



YUNCA

ULE

Ultra Low Emissions



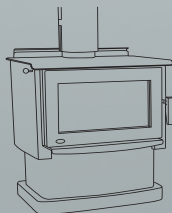

Monte Base
A robust base styling to go with Monte's large glass area.

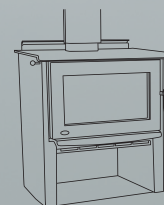

Monte Euro
A merging of styles to give a popular European look with convenient wood store.



Find out more about the Yunca Monte ECO



Emissions	0.4g
Efficiency	82%
ULE Certified	✓
Hot Water Capable	✓

Standard Floor Protector

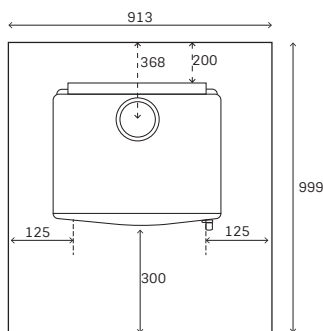

Monte Base

Dimensions

Height:	783mm
Width:	663mm
Depth:	575mm

Clearances

Rear:	200mm
Side:	450mm
Corner:	280mm

Hearth Clearances

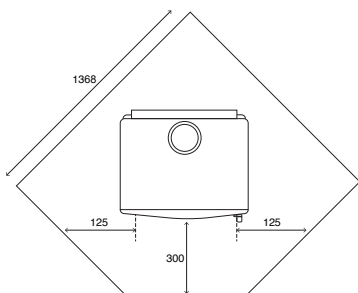

Monte Leg

Dimensions

Height:	730mm
Width:	663mm
Depth:	575mm

Clearances

Rear:	200mm
Side:	435mm
Corner:	245mm

Hearth Clearances

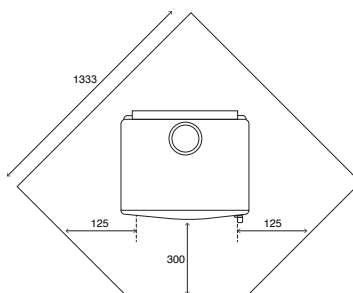

Monte Euro

Dimensions

Height:	781mm
Width:	663mm
Depth:	575mm

Clearances

Rear:	200mm
Side:	350mm
Corner:	200mm

Hearth Clearances

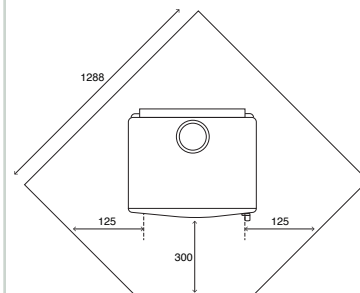

Monte ECO

Only the most environmentally friendly wood heaters earn the **Ultra Low Emission (ULE) certification**, which requires wood heaters to produce **less than 0.5g of smoke** for every 1kg of wood you burn.

The Monte ECO outperforms this with an impressive **0.4g of emissions**. This is accomplished with the stainless steel baffle reburning the smoke inside the firebox, giving you incredible afterburn flames and reduced emissions.

The Australian-made 700-grade vermiculite firebricks increase the firebox temperature by 60%, giving you a cleaner and more efficient burn. With an incredible **82% efficiency rating**, you'll burn less wood every season.

The Monte ECO proudly sits as one of Australia's cleanest burning wood heaters and wears the **ULE certification with honour**.

Additional Features

- Heating capacity of over 200m²
- Optional two-speed fan
- Burn time 10-12 hours

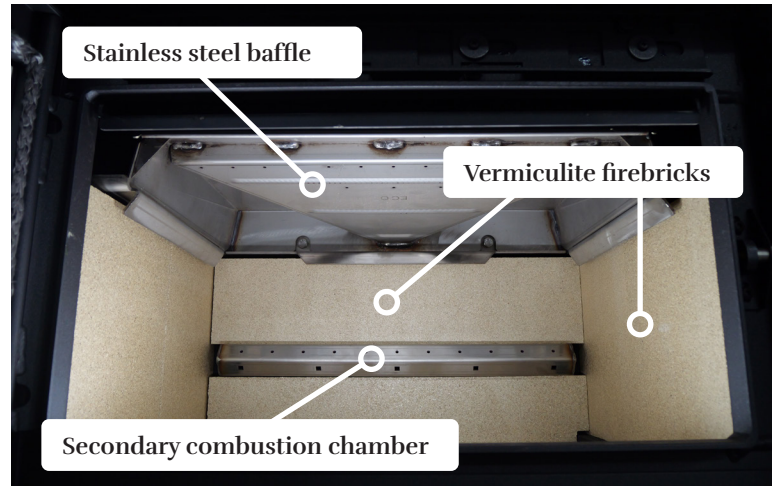

The firebox of the Monte ECO is designed to stay hotter for longer and reburn smoke particles.

Experience the Yunca Monte ECO and enjoy a home that is both warm and environmentally conscious.

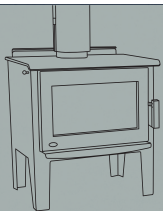

Monte Leg

A traditional styled fire with modern performance features and contemporary slim lines.

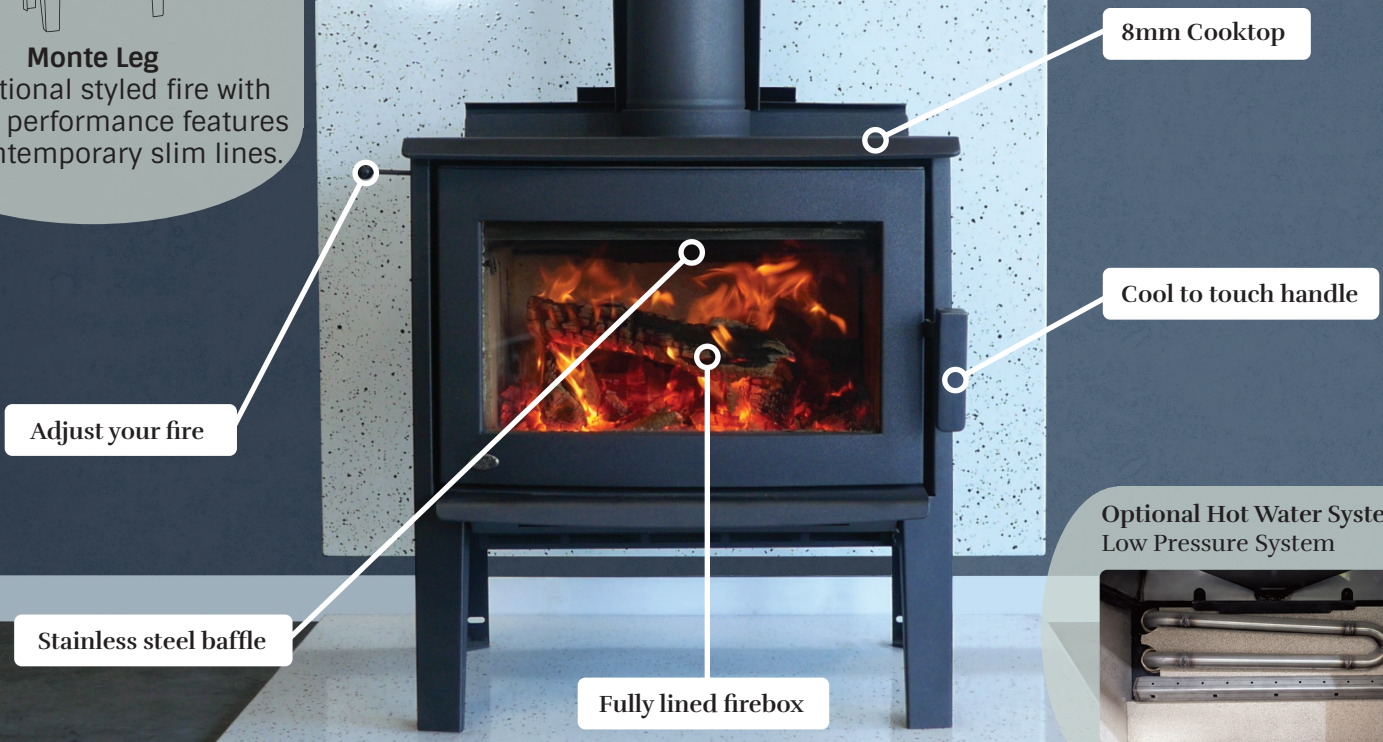

Optional Hot Water System
Low Pressure System



*Available on all models



Why choose Yunca?

For over 40 years, Yunca heaters have not only kept New Zealanders warm, but have also maintained a commitment to environmental sustainability. Yunca heaters boast some of the cleanest emissions worldwide, in alignment with preserving New Zealand and Australia's natural environments. Yunca continue to uphold their dedication to excellence by offering a comprehensive range of parts for models manufactured over four decades ago – wood heaters that are still going strong today.

Available Australia-Wide through
Pivot Stove & Heating's Dealer network

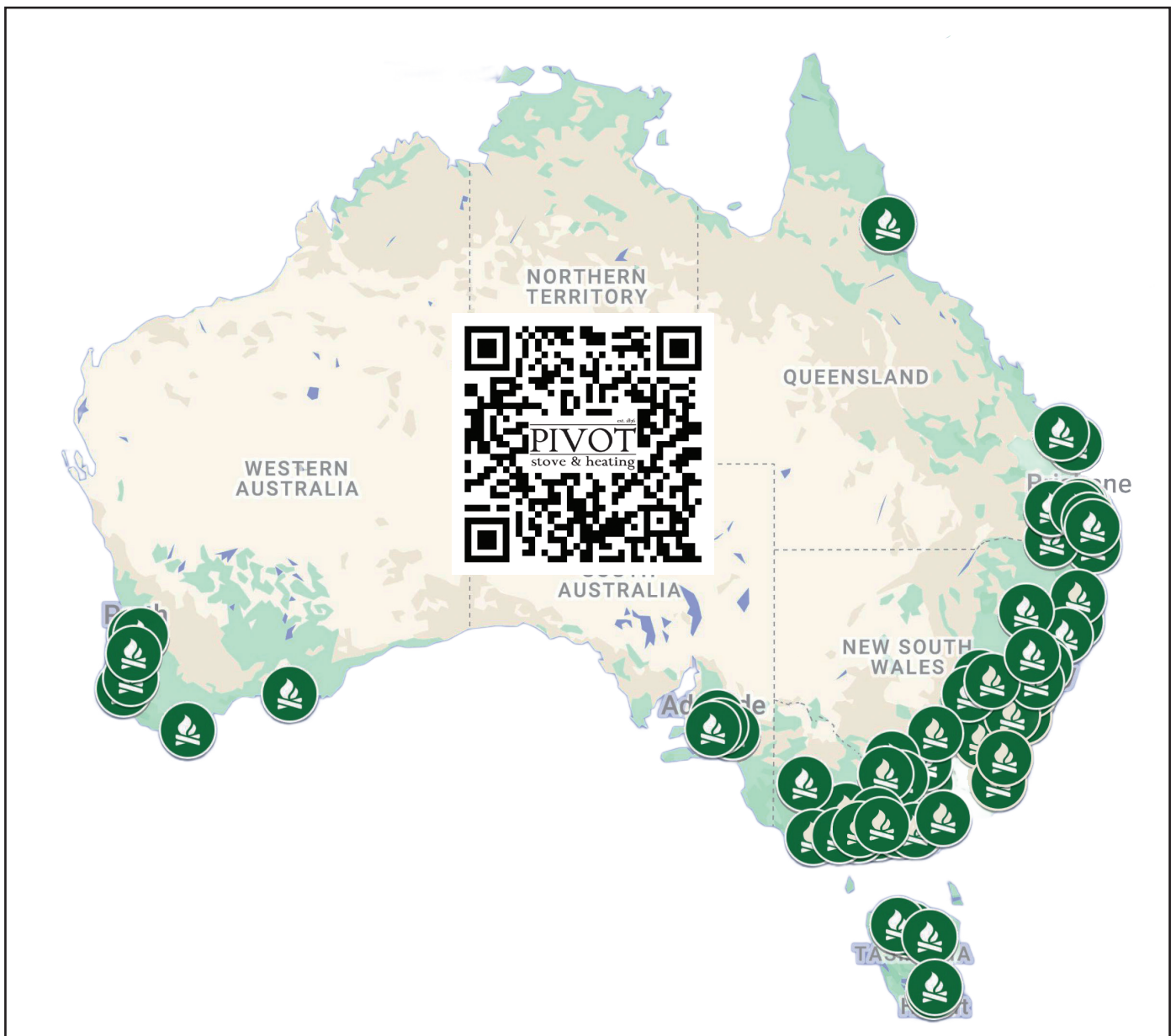

pivotstove.com.au

Details in brochure correct at time of publication.
Scan here for the most up-to-date information.

