

est. 1876

PIVOT

stove & heating

———— Room Seal ————

Flue Kit

Manual

Insulated Room Seal Flue Kit

The Room Seal Flue Kit is an insulated flue kit that uses ceramic insulation to not only ensure your wood stove/heater's flue is running at the optimum temperature, but also offers a room seal solution for your home.

The Room Seal Flue Kit is an air tight solution for **passive homes** – increasing the efficiency of your wood heater by up to 8%

The ceramic insulation ensures your outer temperature is kept extremely low, allowing you to have timbers as close as 25mm from this flue at the ceiling line, and 50mm from timber at the roof line.

3 - 4 Standard Ceiling 4m Flue Kit

Insulated Room Seal Flue Kit Standard Ceiling 4m Flue Kit

Item	QTY	Product Code
A 1500mm x 100mm Adjustable Room Seal Flue (with Locking Bands) Heater diameter: 150mm Outside diameter: 200mm	2	RSP-ASJADT
B 1000mm Room Sealed Flue (with Locking Bands) Heater diameter: 150mm Outside diameter: 200mm	1	RSP-1000
C 1000mm Room Sealed Flue (with Locking Bands) Heater diameter: 150mm Outside diameter: 200mm	1	RSP-1000
D 1000mm Room Sealed Flue (with Locking Bands) Heater diameter: 150mm Outside diameter: 200mm	1	RSP-1000
E Ceiling Ring	1	RSP-COLRGRNG
F 1500mm Room Sealed Flue (with Locking Bands) Heater diameter: 150mm Outside diameter: 200mm	1	RSP-1000
G 1000mm Room Sealed Flue (with Locking Bands) Heater diameter: 150mm Outside diameter: 200mm	1	RSP-1000
H 1000mm Room Sealed Flue (with Locking Bands) Heater diameter: 150mm Outside diameter: 200mm	1	RSP-1000

Flue Assembly

Optional Support Brace

Heat Shield (side view)

Starter Length

NOTE: To assemble flue, first lock into place, second secure locking band around pipe.

NOTE: The optional support brace (N) has the ability to adjust to any angle of adjacent roof beams. There is a 25mm clearance between the flue and any timber at 180°.

NOTE: The heat shield should be positioned on the side of the flue that faces the external wall for additional protection.

5 - 6 Cathedral Ceiling 4m Flue Kit

Insulated Room Seal Flue Kit Cathedral Ceiling 4m Flue Kit

Item	QTY	Product Code
A 1500mm x 100mm Adjustable Room Seal Flue (with Locking Bands) Heater diameter: 150mm Outside diameter: 200mm	2	RSP-ASJADT
B 1000mm Room Sealed Flue (with Locking Bands) Heater diameter: 150mm Outside diameter: 200mm	1	RSP-1000
C 1000mm Room Sealed Flue (with Locking Bands) Heater diameter: 150mm Outside diameter: 200mm	1	RSP-1000
D 1000mm Room Sealed Flue (with Locking Bands) Heater diameter: 150mm Outside diameter: 200mm	1	RSP-1000
E Ceiling Ring	1	RSP-COLRGRNG
F 1500mm Room Sealed Flue (with Locking Bands) Heater diameter: 150mm Outside diameter: 200mm	1	RSP-1000
G 1000mm Room Sealed Flue (with Locking Bands) Heater diameter: 150mm Outside diameter: 200mm	1	RSP-1000
H 1000mm Room Sealed Flue (with Locking Bands) Heater diameter: 150mm Outside diameter: 200mm	1	RSP-1000
I Room Sealed Flue Adapter (Single to Twin) 1500mm - 200mm	1	RSP-ST-ADPT

Starter Length

Optional Support Brace

Ceiling Ring

Heat Shield (side view)

NOTE: The optional support brace (N) has the ability to adjust to any angle of adjacent roof beams. There is a 25mm clearance between the flue and any timber at 180°.

NOTE: The heat shield should be positioned on the side of the flue that faces the external wall for additional protection.

7 - 8 Fully Sealed 4m Flue Kit

Insulated Room Seal Flue Kit Fully Sealed 4m Flue Kit

Item	QTY	Product Code
A 1500mm x 100mm Adjustable Room Seal Flue (with Locking Bands) Heater diameter: 150mm Outside diameter: 200mm	2	RSP-ASJADT
B 1000mm Room Sealed Flue (with Locking Bands) Heater diameter: 150mm Outside diameter: 200mm	1	RSP-1000
C 1000mm Room Sealed Flue (with Locking Bands) Heater diameter: 150mm Outside diameter: 200mm	1	RSP-1000
D 1000mm Room Sealed Flue (with Locking Bands) Heater diameter: 150mm Outside diameter: 200mm	1	RSP-1000
E Ceiling Ring	1	RSP-COLRGRNG
F Wind Coat Stainless Steel Outside diameter: 150mm Inside diameter: 200mm	1	RFS-COIL
G Room Sealed Flue Adapter (Single to Twin) 1500mm - 200mm	1	RSP-ST-ADPT

Optional Support Brace

Flue Assembly

Ceiling Ring

NOTE: The optional support brace (N) has the ability to adjust to any angle of adjacent roof beams. There is a 25mm clearance between the flue and any timber at 180°.

NOTE: To assemble flue, first lock into place, second secure locking band around pipe.

9 - 10 2 Story Wall Penetration Kit

Insulated Room Seal Flue Kit 2 Story Wall Penetration Kit

Item	QTY	Product Code
A Room Sealed Flue Adapter (Single to Twin) 1500mm - 200mm	1	RSP-ST-ADPT
B 1000mm Room Sealed Flue (with Locking Bands) Heater diameter: 150mm Outside diameter: 200mm	1	RSP-1000
C 1000mm Room Sealed Flue (with Locking Bands) Heater diameter: 150mm Outside diameter: 200mm	1	RSP-1000
D 1000mm Room Sealed Flue (with Locking Bands) Heater diameter: 150mm Outside diameter: 200mm	1	RSP-1000
E 45 Degree Room Sealed Flue (with Locking Bands) Heater diameter: 150mm Outside diameter: 200mm	1	RSP-45RSD
F 45 Degree Room Sealed Flue (with Locking Bands) Heater diameter: 150mm Outside diameter: 200mm	1	RSP-45RSD
G 45 Degree Room Sealed Flue (with Locking Bands) Heater diameter: 150mm Outside diameter: 200mm	1	RSP-45RSD
H 45 Degree Room Sealed Flue (with Locking Bands) Heater diameter: 150mm Outside diameter: 200mm	1	RSP-45RSD
I 45 Degree Wall Plate (Painted)	1	RFS-45WP-PAINTED
J 45 Degree Wall Plate (Gal)	1	RFS-45WP-GAL
K Wind Coat Stainless Steel Outside diameter: 150mm Inside diameter: 200mm	1	RFS-COIL

Wall Penetration Detail

Flue Assembly

NOTE: There needs to be 100mm clearance to any timber above the flue (up to 180°) and a 25mm clearance to any timber to the side or underneath.

NOTE: To assemble flue, first lock into place, second secure locking band around pipe.

10 - 11 Rear 4m Flue Kit

Insulated Room Seal Flue Kit Rear Flue Kit

Item	QTY	Product Code
A 1500mm x 100mm Adjustable Room Seal Flue (with Locking Bands) Heater diameter: 150mm Outside diameter: 200mm	1	RSP-ASJADT
B 1000mm Room Sealed Flue (with Locking Bands) Heater diameter: 150mm Outside diameter: 200mm	4	RSP-1000
C Ceiling Ring	1	RSP-COLRGRNG
D Room Sealed Flue Adapter (Single to Twin) 1500mm - 200mm	1	RSP-ST-ADPT
E Wind Coat Stainless Steel Outside diameter: 150mm Inside diameter: 200mm	1	RFS-COIL
F 45 Degree Tee with Cap (with Locking Bands) Heater diameter: 150mm Outside diameter: 200mm	1	RSP-TEE
G Heat Support Brace (Heater diameter: 150mm Outside diameter: 200mm)	2	RSP-WALLBRACE

Wall Penetration

NOTE: There needs to be 100mm clearance to any timber above the flue (up to 180°) and a 25mm clearance to any timber to the side and underneath.

12 - 13 ESSE Room Seal Flue Kit

Insulated Room Seal Flue Kit ESSE and Room Seal Flue 4m Flue Kit

Item	QTY	Product Code
A 1500mm x 100mm Adjustable Room Seal Flue (with Access Door) Heater diameter: 150mm	1	FLUCHDOOR
B 1000mm x 1000mm Stainless Steel Flue (with Locking Bands) Heater diameter: 150mm Outside diameter: 200mm	1	FLUCHDOOR
C 1000mm Room Sealed Flue (with Locking Bands) Heater diameter: 150mm Outside diameter: 200mm	1	FLUCHWELD
D Room Sealed Flue Adapter (Single to Twin) 1500mm - 200mm	1	RSP-ST-ADPT
E Ceiling Ring	1	RSP-COLRGRNG
F 1000mm Room Sealed Flue (with Locking Bands) Heater diameter: 150mm Outside diameter: 200mm	1	RSP-1000
G 1000mm Room Sealed Flue (with Locking Bands) Heater diameter: 150mm Outside diameter: 200mm	1	RSP-1000
H Wind Coat Stainless Steel Outside diameter: 150mm Inside diameter: 200mm	1	RFS-COIL

Optional Support Brace



















Flue Assembly

Ceiling Ring

NOTE: The optional support brace (N) has the ability to adjust to any angle of adjacent roof beams. There is a 25mm clearance between the flue and any timber at 180°.

NOTE: To assemble flue, first lock into place, second secure locking band around pipe.

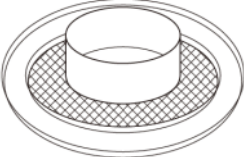
This flue is tested to: AS / NZS2918:2018 APPENDIX F
Approval number: ASFT20050

Individual Item Description		Part Number
RSF 1,000mm Straight Pipe <i>including locking band</i>		RSF-1000
RSF 1,000mm Starter length, partly painted <i>including locking band</i>		RSF-1000-STARTER
RSF 1,000mm Straight Pipe, fully painted <i>including locking band</i>		RFS-1000-PAINTED
RSF 500mm Straight Pipe <i>including locking band</i>		RSF-500
RSF 500mm Straight Pipe, fully painted <i>including locking band</i>		RSF-500-PAINTED
RSF 340mm-500mm Adjustable Pipe <i>including locking band</i>		RSF-ADJUST
RSF 340mm-500mm Adjustable Pipe Painted <i>including locking band</i>		RSF-ADJUST-PAINTED
RSF 90° Tee with Cap <i>including locking band</i>		RSF-TEE
RSF End cap		RSF-CAP
RSF 45° Bend <i>including locking band</i>		RSF-45oBEND
RSF 45° Bend Painted <i>including locking band</i>		RSF-45oBEND-PAINTED
RSF Starter		RSF-STARTER
RSF Support		RSF-SUPPORT
RSF Cowl <i>including locking band</i>		RSF-COWL
RFS locking band		RSF-LOCKINGBAND
RSF 150mm x 1,000mm Painted Stainless		RSF-6PAINT
RSF 1,000mm Painted Heat Shield		RSF-SHIELD
RSF 200mm Ceiling Ring		RSF-CEILINGRING
RSF 200mm Ceiling Ring 15°		RSF-15CEILINGRING
RSF 200mm Ceiling Ring 30°		RSF-30CEILINGRING
RSF 200mm Ceiling Ring 45°		RSF-45CEILINGRING
RSF 45° Wall Plate Painted		RSF-45WALLPLATE-PAINTED
RSF 45° Wall Plate Gal		RSF-45WALLPLATE-GAL

Insulated Room Seal Flue Kit

Standard Ceiling 4m Flue Kit

Standard Flue Kit

	Item	QTY	Product Code
A	1000mm 6" Single skin flue Painted black Diameter: 150mm	2	RSF-6PAINT
B	1000mm starter length, end painted for drop box Inside diameter: 150mm Outside diameter: 200mm	1	RSF-1000 Starter
C	1000mm Room Sealed Flue (with Locking Band) Inside diameter: 150mm Outside diameter: 200mm	1	RSF-1000
D	1000mm Heat Shield Black	1	RSF-SHIELD
E	Ceiling Ring	1	RSF-CEILINGRING
F	Wind Cowl Stainless Steel Inside diameter: 150mm Outside diameter: 200mm	1	RSF-COWL
G	Room Sealed Flue Adapter Single to twin 150mm - 200mm	1	RSF-STARTER

Flue Assembly

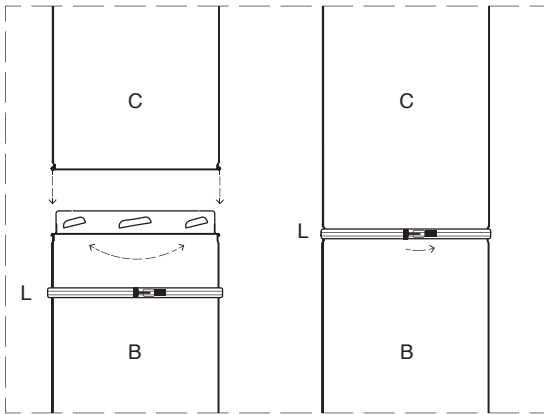

NOTE:
To assemble flue, first lock into place, second secure locking band around joint

Optional Support Brace

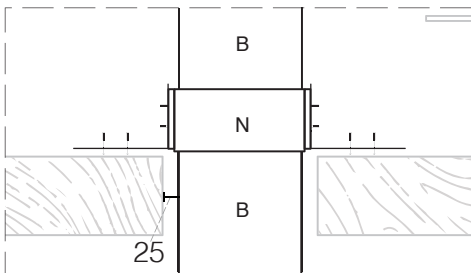

NOTE:
The optional support brace (N) has the ability to adjust to any angle of adjacent roof beams
There is a 25mm clearance between the flue and any timber at all times

Starter Length

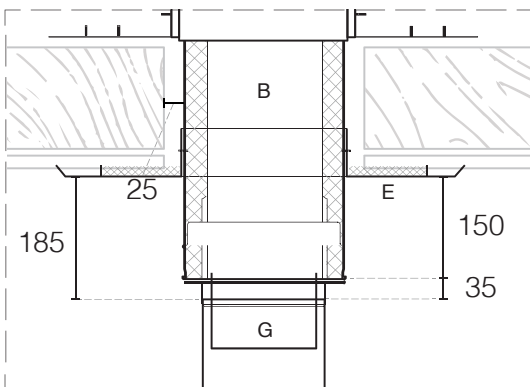

NOTE:
150mm single skin flue (A) must terminate 185mm from the ceiling. The 200mm starter length (B) dropping 150mm into the room, with the tail dropping into the A flue
There is a 25mm clearance between the flue and any timber at all times

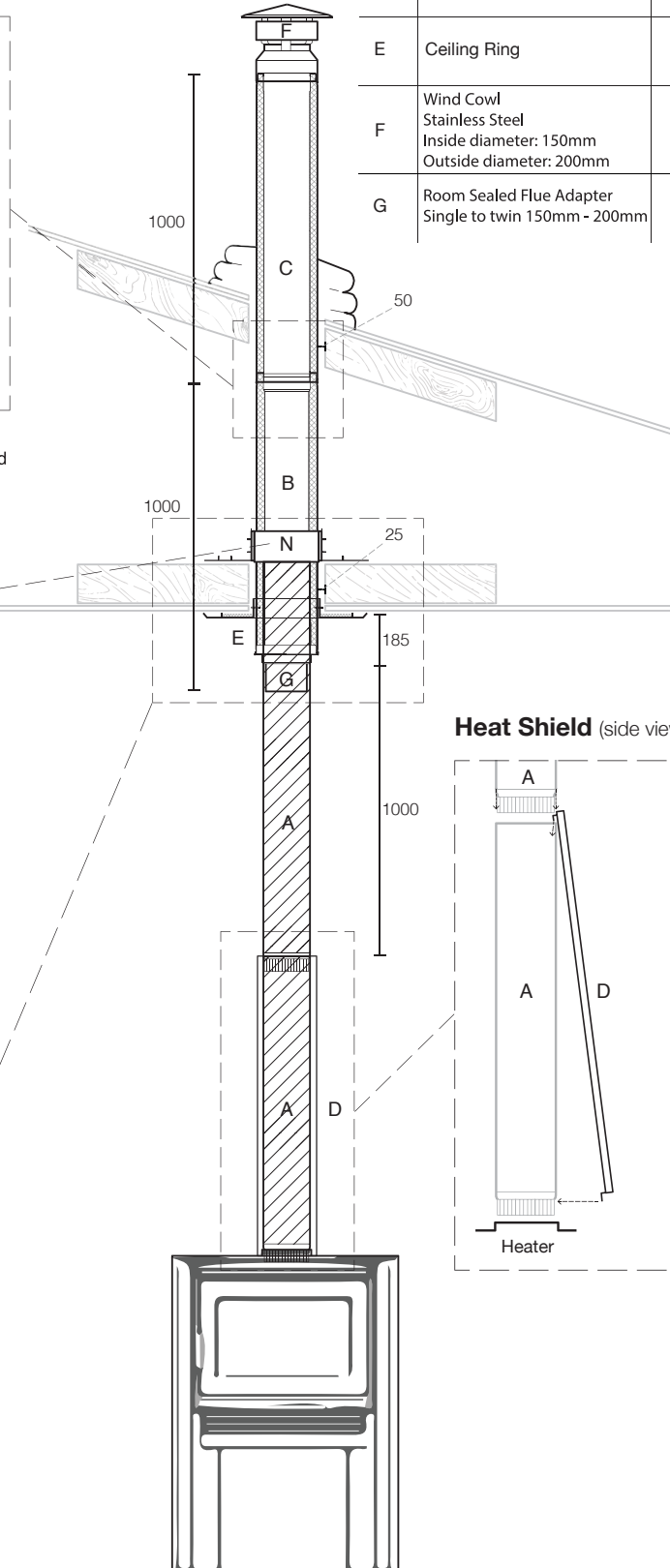

Heat Shield (side view)

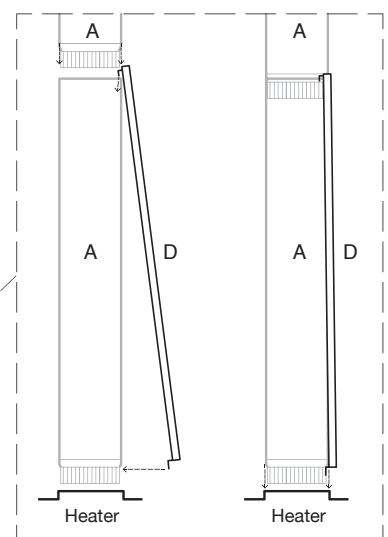

To Order: RSFSTANDARD

Insulated Room Seal Flue Kit Standard Ceiling 4m Flue Kit

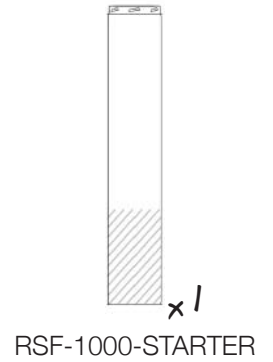
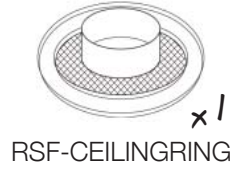
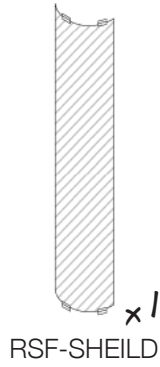
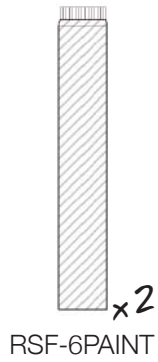

OPTIONAL

RSF Support



Part Number

RSF-SUPPORT

Description

Part Number

RSF 152mm x 1,000mm Painted Stainless

RSF-6PAINT

RSF 152mm x 1,000mm Painted Stainless

RSF-6PAINT

RSF 1,000mm Painted Heat Shield

RSF-SHIELD

RSF 200mm Ceiling Ring

RSF-CEILINGRING

RSF Starter

RSF-STARTER

RSF 1,000mm Starter length, partly painted
including locking band

RSF-1000-STARTER

RSF 1,000mm Straight Pipe
including locking band

RSF-1000

RSF Cowl
including locking band

RSF-COWL

Insulated Room Seal Flue Kit

Cathedral Ceiling 4m Flue Kit

Starter Length

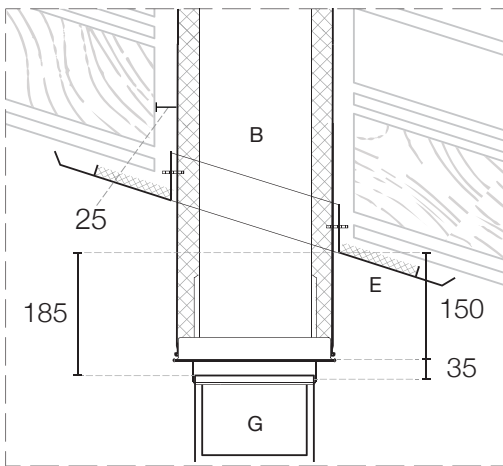

NOTE:
150mm single skin flue (A) must terminate 185mm from the ceiling (lowest point the flue passes through). The 200mm starter length (B) dropping 150mm into the room, with the tail dropping into the A flue
There is a 25mm clearance between the flue and any timber at all times

Ceiling Ring

Ceiling Rings can adjust 8° +/-
RSF-CEILINGRING suits 0° to 8° pitch ceiling
RSF-15CEILINGRING suits 7° to 23° pitch ceiling
RSF-30CEILINGRING suits 22° to 38° pitch ceiling
RSF-45CEILINGRING suits 37° to 53° pitch ceiling

Heat Shield (side view)

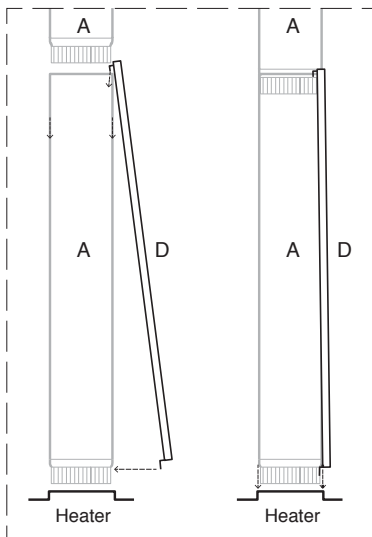

NOTE:
The heat shield should be positioned on the side of the flue that faces the nearest wall for additional protection

Optional Support Brace

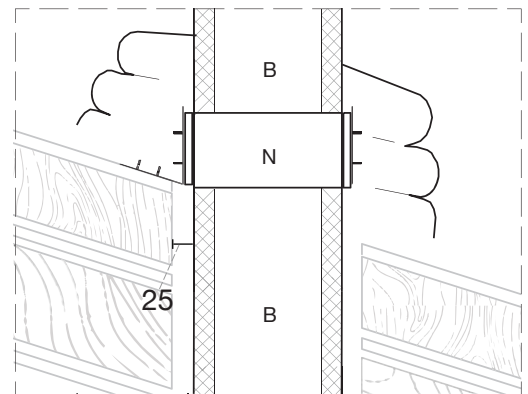

NOTE:
The optional support brace (N) has the ability to adjust to any angle of adjacent roof beams
There is a 25mm clearance between the flue and any timber at all times

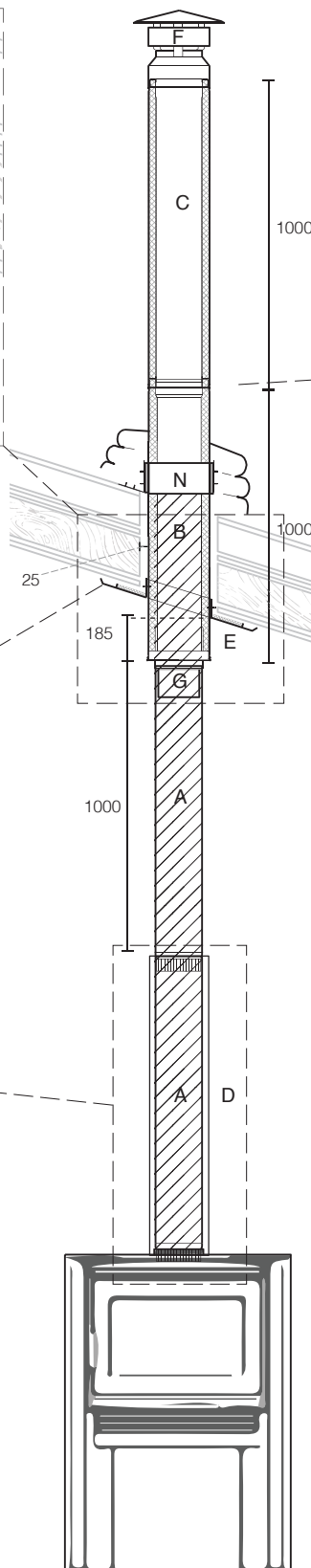

Item	QTY	Product Code
A	2	RSF-6PAINT
B	1	RSF-1000 Starter
C	1	RSF-1000
D	1	RSF-SHIELD
E	1	RSF-CEILINGRING RSF-15CEILINGRING RSF-30CEILINGRING RSF-45CEILINGRING
F	1	RSF-COWL
G	1	RSF-STARTER

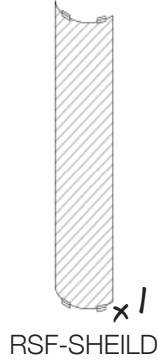
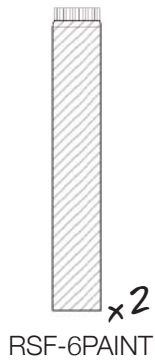

Select one:

- RSF-CEILINGRING
- RSF-15CEILINGRING
- RSF-30CEILINGRING
- RSF-45CEILINGRING

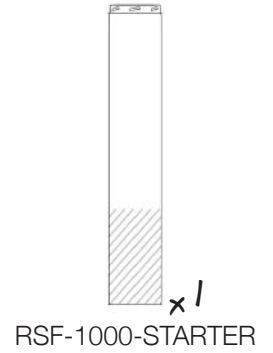

OPTIONAL

RSF Support



Part Number

RSF-SUPPORT

Description

Part Number

RSF 152mm x 1,000mm Painted Stainless

RSF-6PAINT

RSF 152mm x 1,000mm Painted Stainless

RSF-6PAINT

RSF 1,000mm Painted Heat Shield

RSF-SHIELD

RSF 200mm Ceiling Ring

SELECT ONE

Ceiling Rings can adjust 8°
 10° suits 0° to 8° pitch ceiling
 15° suits 7° to 23° pitch ceiling
 30° suits 22° to 38° pitch ceiling
 45° suits 37° to 53° pitch ceiling

RSF-CEILINGRING

RSF-15CEILINGRING

RSF-30CEILINGRING

RSF-45CEILINGRING

RSF Starter

RSF-STARTER

RSF 1,000mm Starter length, partly painted
including locking band

RSF-1000-STARTER

RSF 1,000mm Straight Pipe
including locking band

RSF-1000

RSF Cowl
including locking band

RSF-COWL

Insulated Room Seal Flue Kit

Fully Sealed 4m Flue Kit

Optional Support Brace

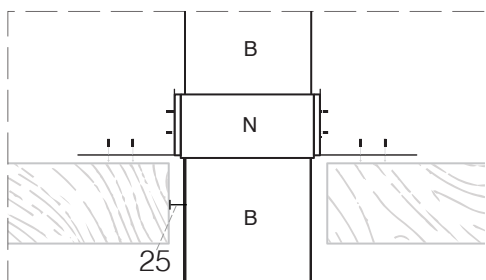

NOTE:
The optional support brace (N) has the ability to adjust to any angle of adjacent roof beams
There is a 25mm clearance between the flue and any timber at all times

Flue Assembly

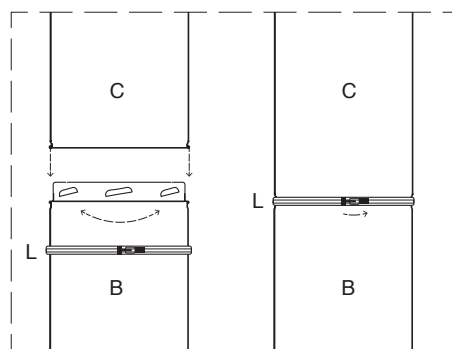

NOTE:
To assemble flue, first lock into place, second secure locking band around joint

Ceiling Ring

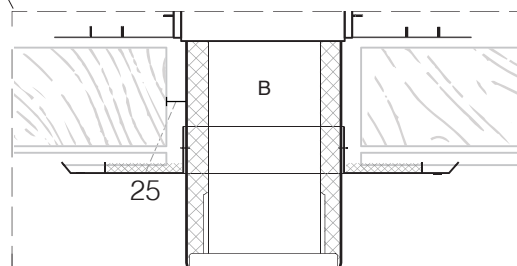

NOTE:
There is a 25mm clearance between the flue and any timber at all times

Fully Sealed Flue Kit

	Item	QTY	Product Code
O	1000mm RSF, painted black (with Locking Band) Inside diameter: 150mm Outside diameter: 200mm	2	RFS-1000-PAINTED
B	1000mm starter length, end painted for drop box Inside diameter: 150mm Outside diameter: 200mm	1	RSF-1000 Starter
C	1000mm Room Sealed Flue (with Locking Band) Inside diameter: 150mm Outside diameter: 200mm	1	RSF-1000
E	Ceiling Ring	1	RSF-CEILINGRING
F	Wind Cowl Stainless Steel Inside diameter: 150mm Outside diameter: 200mm	1	RFS-COWL
G	Room Sealed Flue Adapter Single to twin 150mm - 200mm	1	RSF-STARTER

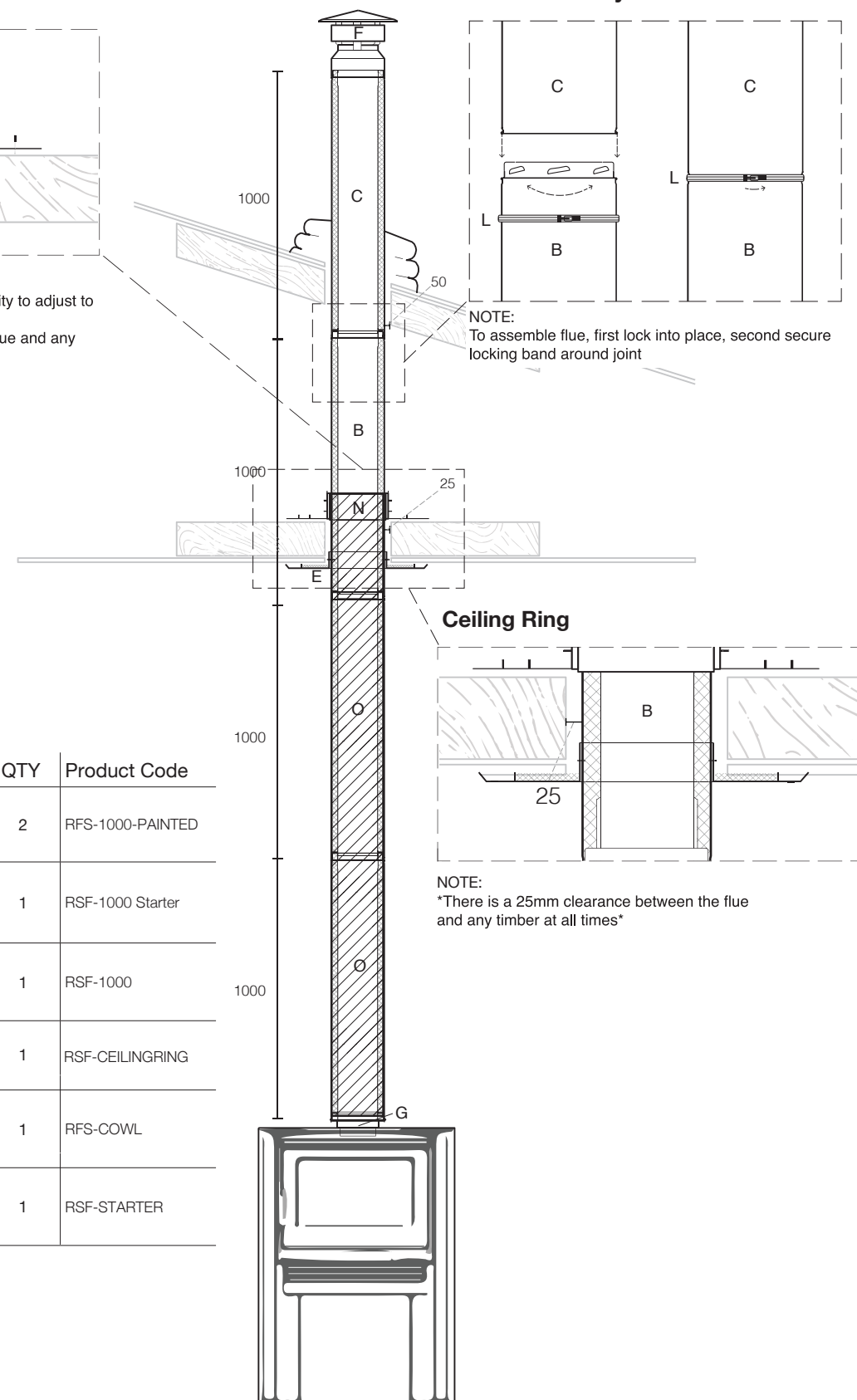

To Order: RSFREDUCEDCLEARANCE

Insulated Room Seal Flue Kit Fully Sealed 4m Flue Kit

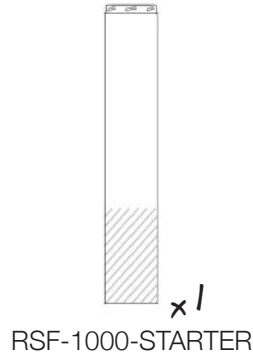
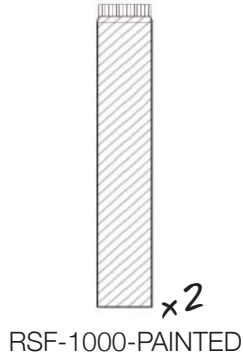

OPTIONAL

RSF Support



Part Number

RSF-SUPPORT

Description

Part Number

RSF Starter

RSF-STARTER

RSF 1,000mm Starter length, fully painted
including locking band

RSF-1000-PAINTED

RSF 1,000mm Starter length, fully painted
including locking band

RSF-1000-PAINTED

RSF 1,000mm Starter length, partly painted
including locking band

RSF-1000-STARTER

RSF 200mm Ceiling Ring

RSF-CEILINGRING

RSF 1,000mm Straight Pipe
including locking band

RSF-1000

RSF Cowl
including locking band

RSF-COWL

Insulated Room Seal Flue Kit

2 Story Wall Penetration Kit

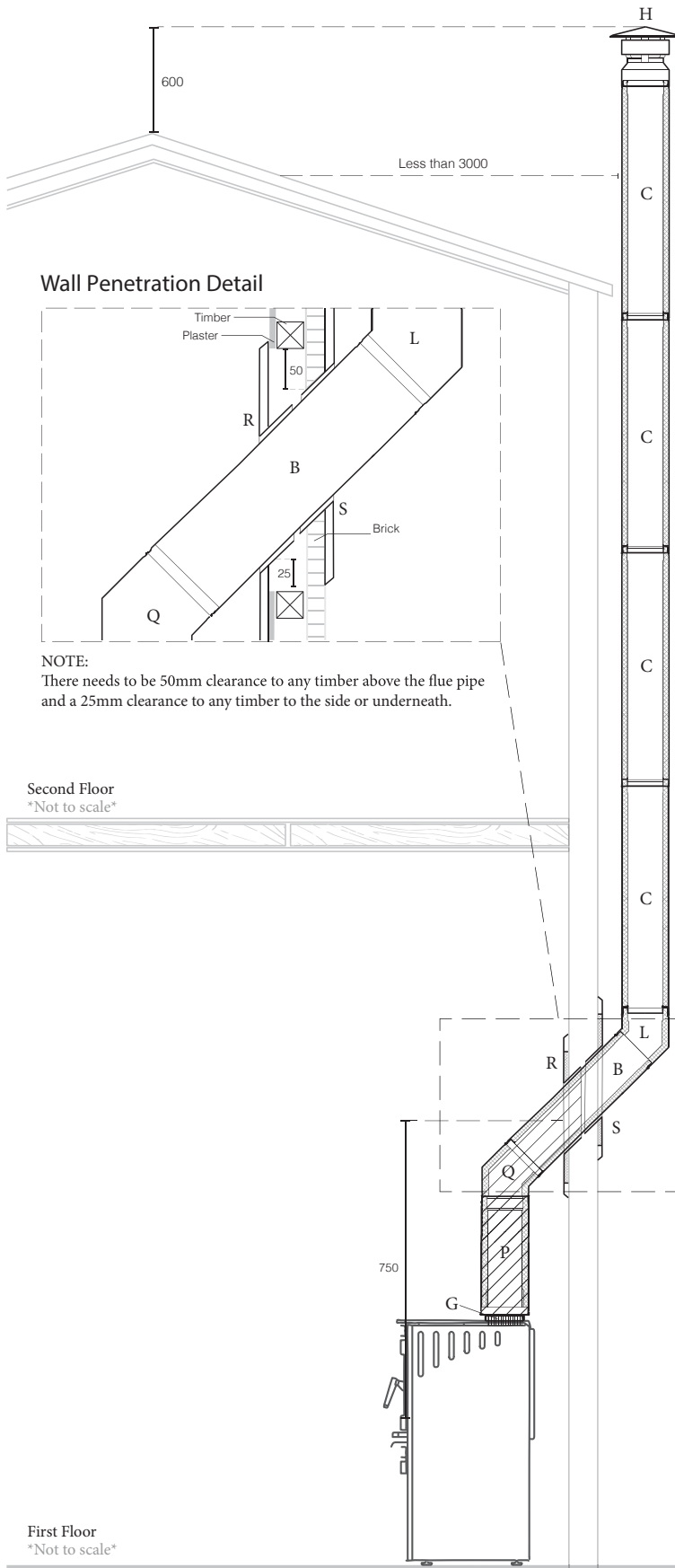

Wall Penetration Detail

NOTE:
There needs to be 50mm clearance to any timber above the flue pipe and a 25mm clearance to any timber to the side or underneath.

2 Story Wall Penetration Kit

Item	QTY	Product Code
G	1	RSF-STARTER
P	1	RSF-500 Painted
B	1	RSF-1000 Starter
C	4	RSF-1000
L	1	RSF-45oBEND
Q	1	RSF-45oBEND-PAINTED
R	1	RSF-45WALL-PLATE-PAINTED
S	1	RSF-45WALL-PLATE-GAL
H	1	RSF-COWL

Flue Assembly

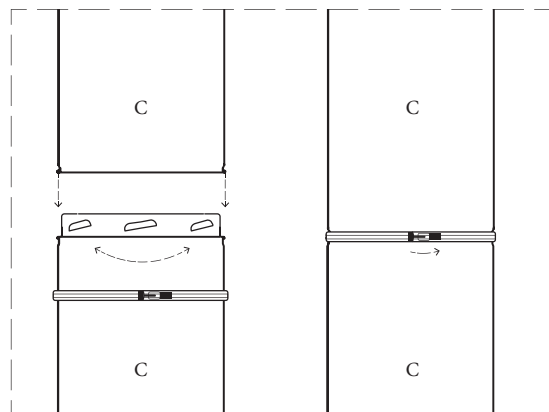

NOTE:
To assemble flue, first lock into place, second secure locking band around joint

OPTIONAL

RSF Support



Part Number

RSF-SUPPORT

To Order: RSFWALLPEN

**Insulated Room Seal Flue Kit
2 Story Wall Penetration Kit**

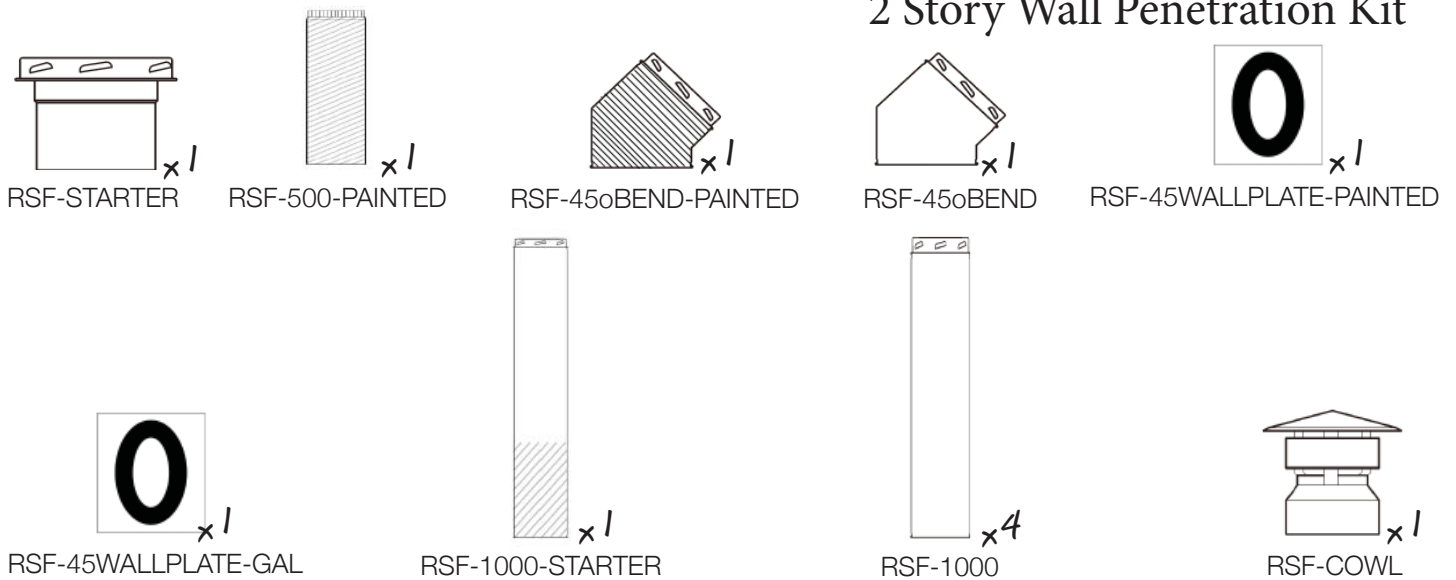

Description	Part Number
RSF Starter	RSF-STARTER
RSF 5000mm Straight Pipe, fully painted <i>including locking band</i>	RSF-500-PAINTED
RSF 45° Bend Painted <i>including locking band</i>	RSF-45oBEND-PAINTED
RSF 1,000mm Starter length, partly painted <i>including locking band</i>	RSF-1000-STARTER
RSF 45° Bend <i>including locking band</i>	RSF-45oBEND
RSF 45° Wall Plate Painted	RSF-45WALLPLATE-PAINTED
RSF 45° Wall Plate Gal	RSF-45WALLPLATE-GAL
RSF 1,000mm Straight Pipe <i>including locking band</i>	RSF-1000
RSF 1,000mm Straight Pipe <i>including locking band</i>	RSF-1000
RSF 1,000mm Straight Pipe <i>including locking band</i>	RSF-1000
RSF 1,000mm Straight Pipe <i>including locking band</i>	RSF-1000
RSF Cowl <i>including locking band</i>	RSF-COWL

Insulated Room Seal Flue Kit

Rear Flue Kit

Item	QTY	Product Code
A	1	RSF-ADJUSTPAINTED
C	4	RSF-1000
E	1	RSF-CEILINGRING
J	1	RSF-8WALLPLATE
G	1	RSF-STARTER
H	1	RSF-COWL
T	1	RSF-TEE
V	2	RSF-WALLBRACE

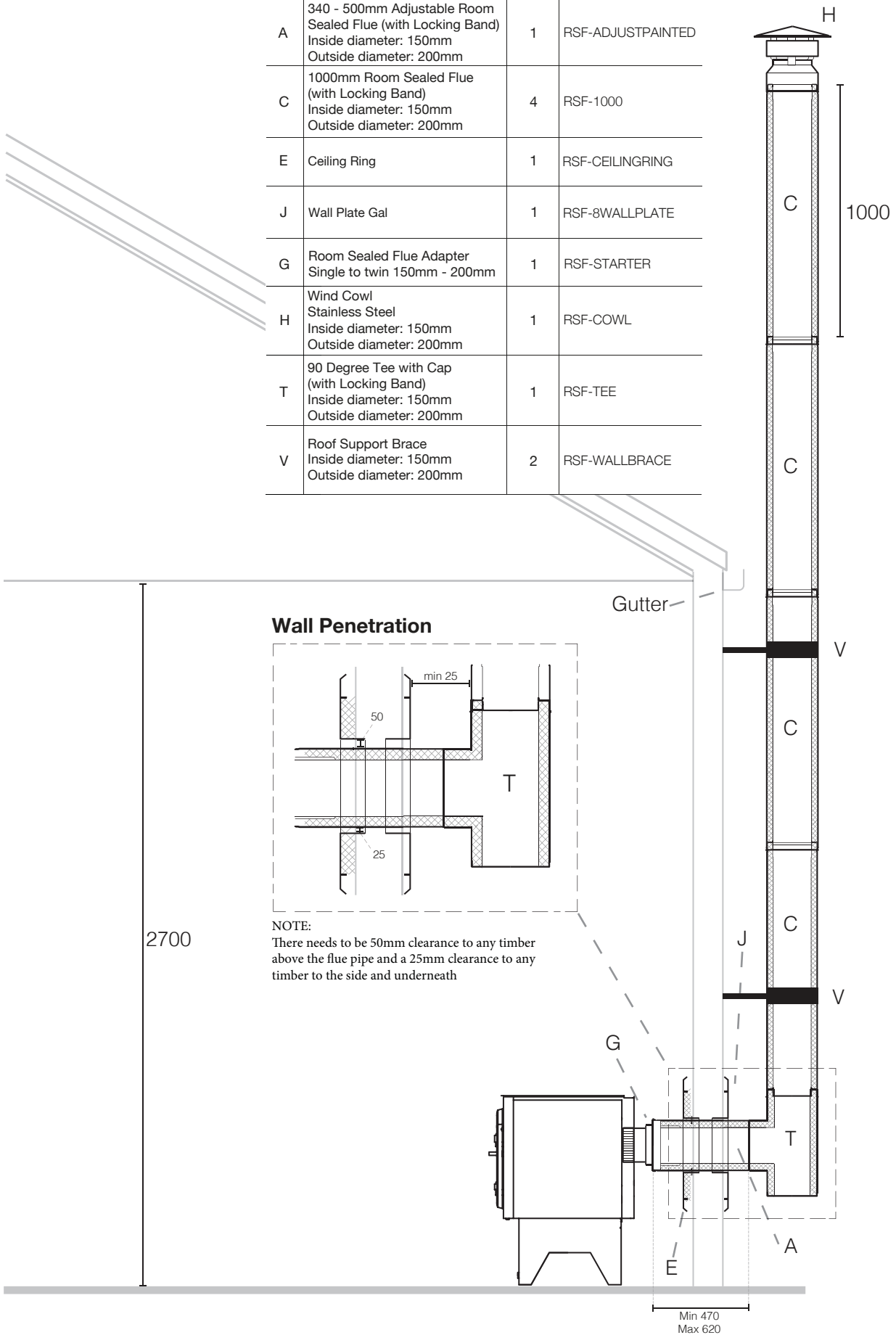

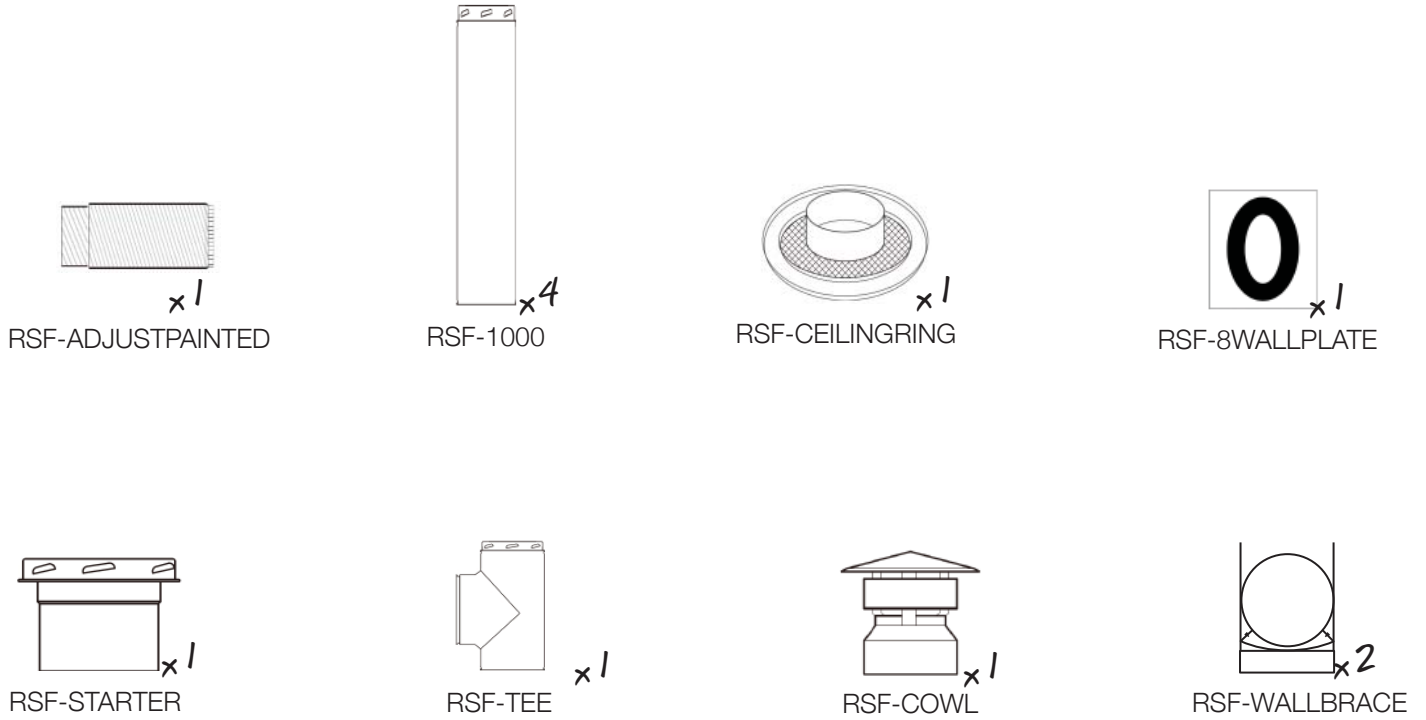

Description	Part Number
RSF 340mm-500mm Adjustable Pipe Painted <i>including locking band</i>	RSF-ADJUSTPAINTED
RSF 1,000mm Straight Pipe <i>including locking band</i>	RSF-1000
RSF 200mm Ceiling Ring	RSF-CEILINGRING
RSF Wall Plate Gal	RSF-8WALLPLATE
RSF Starter	RSF-STARTER
RSF 90° Tee with Cap <i>including locking band</i>	RSF-TEE
RSF Cowl <i>including locking band</i>	RSF-COWL
RSF Wall Brace	RSF-WALLBRACE

Insulated Room Seal Flue Kit

ESSE and Room Seal Flue 4m Flue Kit

Item	QTY	Product Code
A	1	FL6CHDOOR
B	1	FL6CHNODOOR
C	1	FLHEATSHIELD
D	1	RSF-STARTER
E	1	RSF-CEILINGRING
F	1	RSF-1000 Starter
G	1	RSF-1000
H	1	RFS-COWL

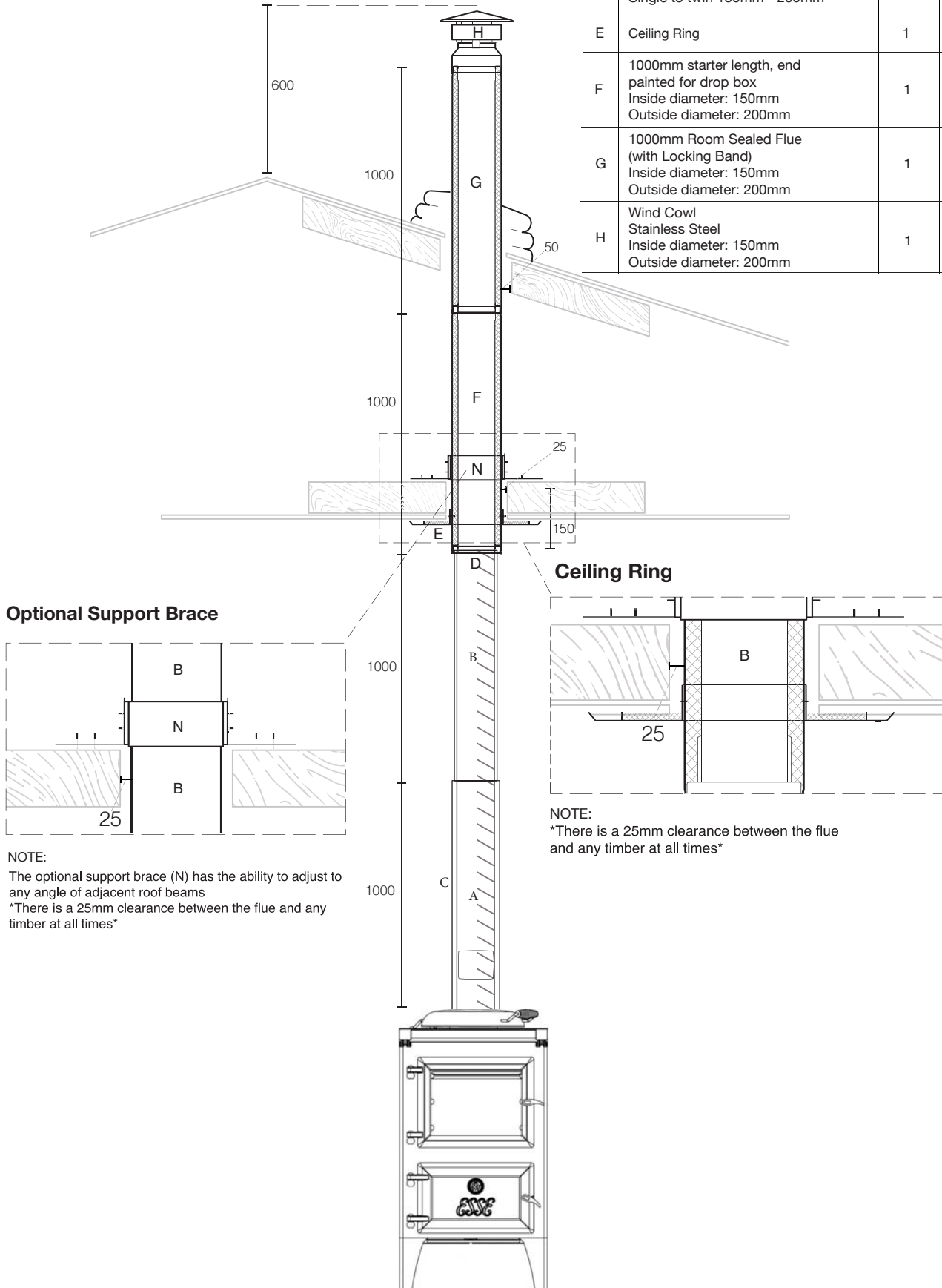

To Order: RSFESSE

Insulated Room Seal Flue Kit ESSE Room Seal Flue Kit

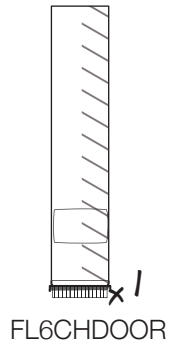

FL6CHDOOR

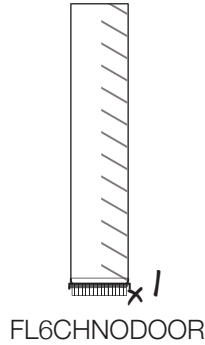

FL6CHNODOOR

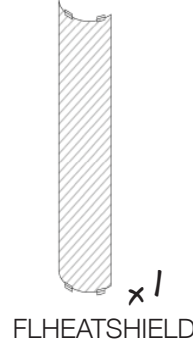

FLHEATSHIELD



RSF-STARTER



RSF-CEILINGRING

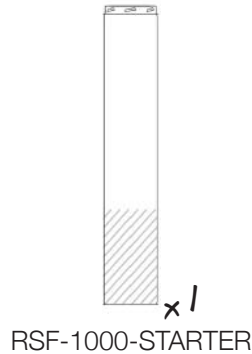

RSF-1000-STARTER



RSF-1000



RSF-COWL

OPTIONAL

RSF Support



Part Number

RSF-SUPPORT

Description

Part Number

150mm x 1,000mm Stainless Flue
with Access Door, Painted StoveBright Charcoal

FL6CHDOOR

150mm x 1,000mm Stainless Flue
Painted StoveBright Charcoal

FL6CHNODOOR

1,000mm Heat Shield
Painted StoveBright Charcoal

FLHEATSHIELD

RSF 200mm Ceiling Ring

RSF-CEILINGRING

RSF Starter

RSF-STARTER

RSF 1,000mm Starter length, partly painted
including locking band

RSF-1000-STARTER

RSF 1,000mm Straight Pipe
including locking band

RSF-1000

RSF Cowl
including locking band

RSF-COWL

Insulated Room Seal Flue Kit

Bracing Options

Roof Bracing Kit
RSF-ROOFBRACE



Flue Support Bracket
RSF-SUPPORT

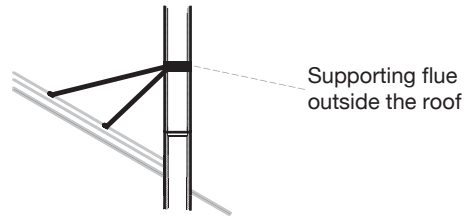
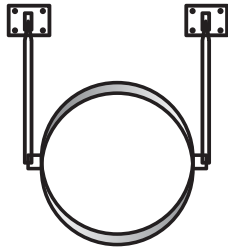

Adjustable Wall Brace
RSF-WALLBRACE

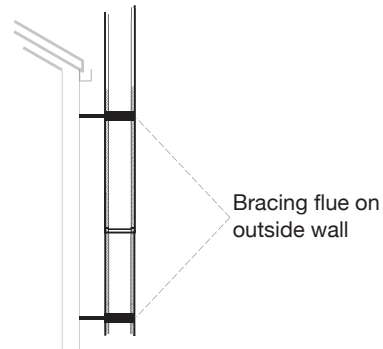
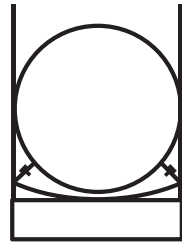

pivotstove.com.au

1300 4 PIVOT

1300 4 74868



7 Year Limited Warranty on Flue
1 Year Limited Warranty on Cowl & Paint
Please see full Terms & Conditions