

SCULPT™

FIREPLACE
COLLECTION

Download the latest manual version on our website

Edition: 26/10/2022

AXIS

H1200/DS | H1400 | H1600/DS | H1600XXL/DS

H1200VLG/D | H12003V | EPI950

INSTALLATION & USER GUIDE

1. SPECIFICATIONS

2. PRELIMINARY INSTALL GUIDE

3. OUTDOOR AIR KIT

4. COMPONENTS LIST

5. INBUILT INSTALLATION

5.1 MASONRY BRICK INSTALLATION

5.2 HEBEL INSTALLATION

6. INBUILT INTO ISLAND WALL
NO COMBUSTIBLE SURROUNDINGS

7. APPLIANCE DETAILS

8. OPERATION & MAINTENANCE

9. TEST RESULTS

10. WARRANTY

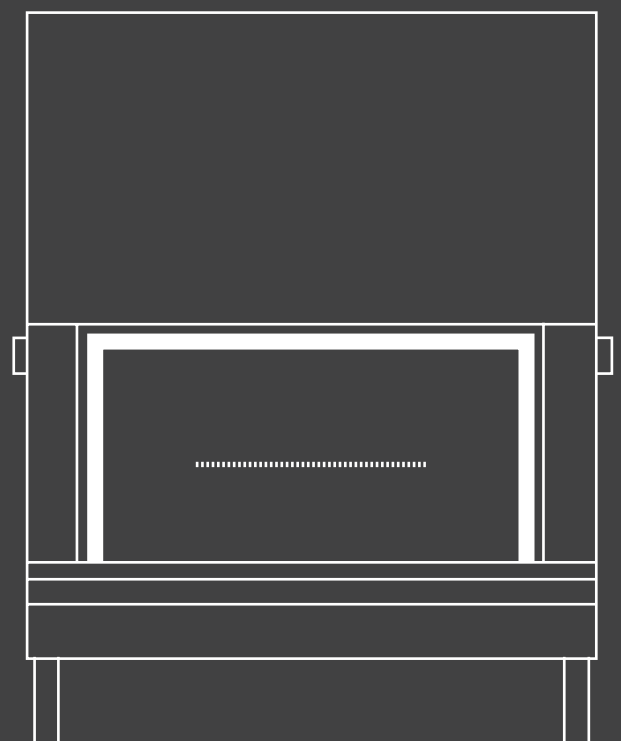

NOTICE TO INSTALLER:

These instructions must be left with the owner, who should retain for future use.

COMPLIANCE PLATE AND SERIAL NUMBER.

The instructions in this manual are recommendations only, the distributor and manufacturer bears no liability to the interpretation of these instructions. Please ensure to download the latest version of this manual from our website: www.sculptfireplaces.com.au/installation-manuals/

All rights retained © Copyright 2022 Sculpt Fireplaces Collection

CONGRATULATIONS!

Thank you for choosing Sculpt Fireplaces as your heater of choice.

Your fireplace is the result of careful design, artisan engineering and safety tests. If it is properly installed, used and maintained, you may be sure that you will have an outstanding heating feature in your home for years to come.

We advise you to read through this guide in order to become acquainted with the installation methods specific to your fireplace.

It is recommended that this fireplace be installed by a qualified and licensed trades professional. You will find in this guide the answers to most of your questions, should you require further assistance we recommend you contact your retailer.

Before igniting your fireplace for the first time, please carefully read this manual.

Follow @sculptfireplacecollection on Instagram, SculptFireplaceCollection on Facebook and be sure to post your latest masterpiece installed with the hashtag #sculptfires.

We hope we've helped make you the envy of your friends this winter and for years to come.

From all of us,
Sculpt Fireplace Collection



This installation manual at times is updated, to view the latest manual please refer to the support section of the Sculpt Fireplace Collection website.

ALL FIREPLACES IN THIS MANUAL CONFORM TO AUSTRALIAN AND NEW ZEALAND STANDARDS AS/NZS 2918:2018 DOMESTIC SOLID FUEL BURNING APPLIANCES & AS/NZS 4012/4013(2014).

IMPORTANT

Heating capacity of the following appliances are a guide only and refers to areas with 2.4m ceilings and 6 or more star rated buildings. Heating output may vary depending on factors such as building characteristics, quality of insulation, type of firewood used and climate zone.

All dimensions shown are approximate. Check all dimensions accurately prior to installation. In line with our policy of continuous improvement, we reserve the right to alter specifications without notice.

All units comply and MUST be installed to Australian & New Zealand Standard AS/NZS 2918:2018. When in use some parts may become hot. A suitable fire guard is recommended where very young, elderly or infirm are concerned.

The instructions in this manual are recommendations only, the distributor and manufacturer bears no liability to the interpretation of these instructions.

© Copyright 2022 Sculpt Fireplace Collection (ACN: 169053883)

AXIS H1200

MATERIAL	Solid steel firebox with 60mm thick fire bricks
KW OUTPUT	25kW+
HEATING CAPACITY*	Up to 200m ² *
FACACE	Clean frame-less design(trim options available)
GLASS DOOR	Secure swing & lift door
MINIMUM FLUE HEIGHT	5.4m
FLUE SIZES	250mm, 300mm, 350mm
HOT AIR TRANSFER KIT	Optional extra - includes Two ducts and two registers
OUTSIDE AIR KIT	Recommended for well insulated homes
WARRANTY	10 year fire brick & 5 year firebox warranty**
WEIGHT	380kg
LEGS**	Adjustable 180mm-600mm
HEARTH DIMENSIONS***	Min 1000mm in front of any part of fireplace, 250mm on either side & 100mm thick

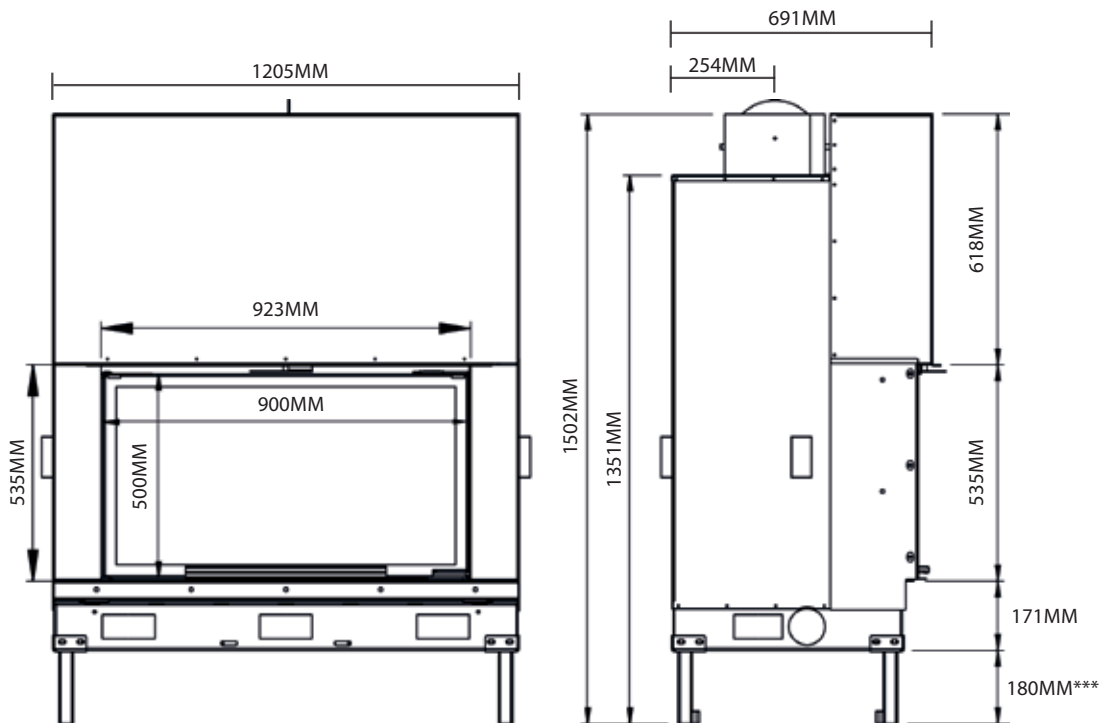

* Heating capacity of the following appliances are a guide only and refers to areas with 2.4m ceilings and 6 or more star rated buildings. Heating output may vary depending on factors such as building characteristics, quality of insulation, type of firewood used and climate zone.

** See warranty pg. 53 of the manual

*** To reduce hearth dimensions, view tables on page 15 of this manual

AXIS H1200DS

MATERIAL	Solid steel firebox with 60mm thick fire bricks
KW OUTPUT	25kW+
HEATING CAPACITY*	Up to 200m ² *
FACACE	Clean frame-less design(trim options available)
GLASS DOOR	Secure swing & lift door
MINIMUM FLUE HEIGHT	5.4m
FLUE SIZES	250mm, 300mm, 350mm
HOT AIR TRANSFER KIT	Optional extra - includes Two ducts and two registers
OUTSIDE AIR KIT	Recommended for well insulated homes
WARRANTY	10 year fire brick & 5 year firebox warranty**
WEIGHT	380kg
LEGS**	Adjustable 180mm-600mm
HEARTH DIMENSIONS***	Min 1000mm in front of any part of fireplace, 250mm on either side & 75mm thick

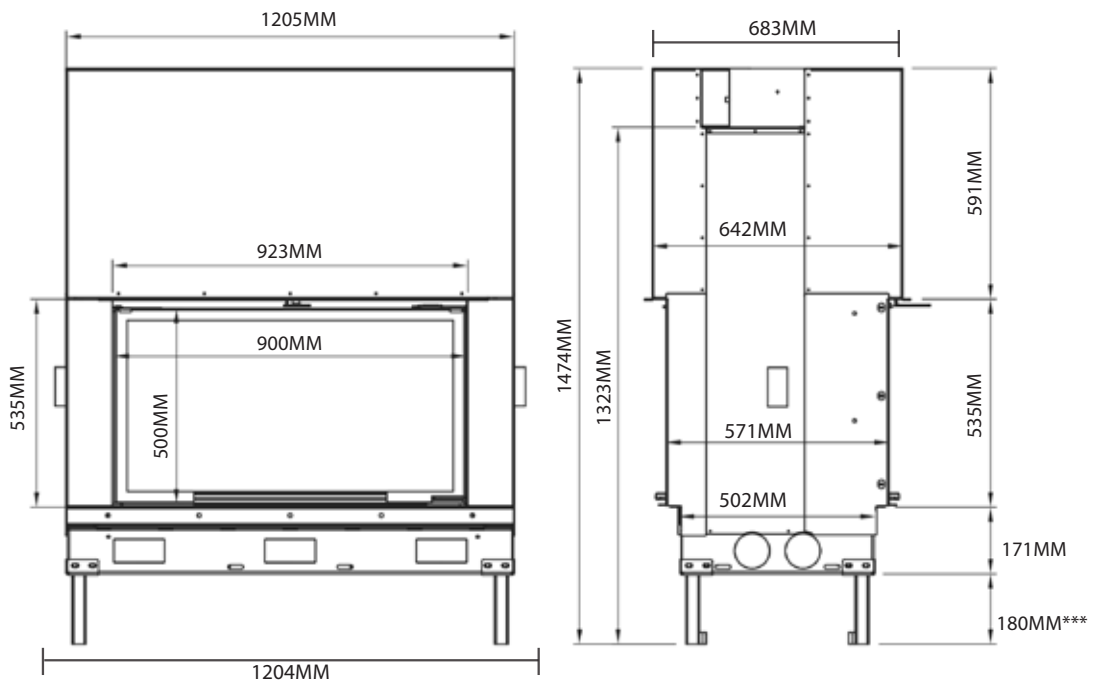

*Heating capacity of the following appliances are a guide only and refers to areas with 2.4m ceilings and 6 or more star rated buildings. Heating output may vary depending on factors such as building characteristics, quality of insulation, type of firewood used and climate zone.

**See warranty pg. 53 of the manual

*** To reduce hearth dimensions, view tables on page 15 of this manual

AXIS H1400

MATERIAL	Solid steel firebox with 60mm thick fire bricks
KW OUTPUT	25kW+
HEATING CAPACITY*	Up to 280-320m ² *
FACACE	Clean frame-less design(trim options available)
GLASS DOOR	Secure swing & lift door
MINIMUM FLUE HEIGHT	5.4m
FLUE SIZES	300mm, 350mm, 400mm
HOT AIR TRANSFER KIT	Optional extra - includes Two ducts and two registers
OUTSIDE AIR KIT	Recommended for well insulated homes
WARRANTY	10 year fire brick & 5 year firebox warranty**
WEIGHT	400kg
LEGS**	Adjustable 180mm-600mm
HEARTH DIMENSIONS***	Min 1000mm in front of any part of fireplace, 250mm on either side & 100mm thick

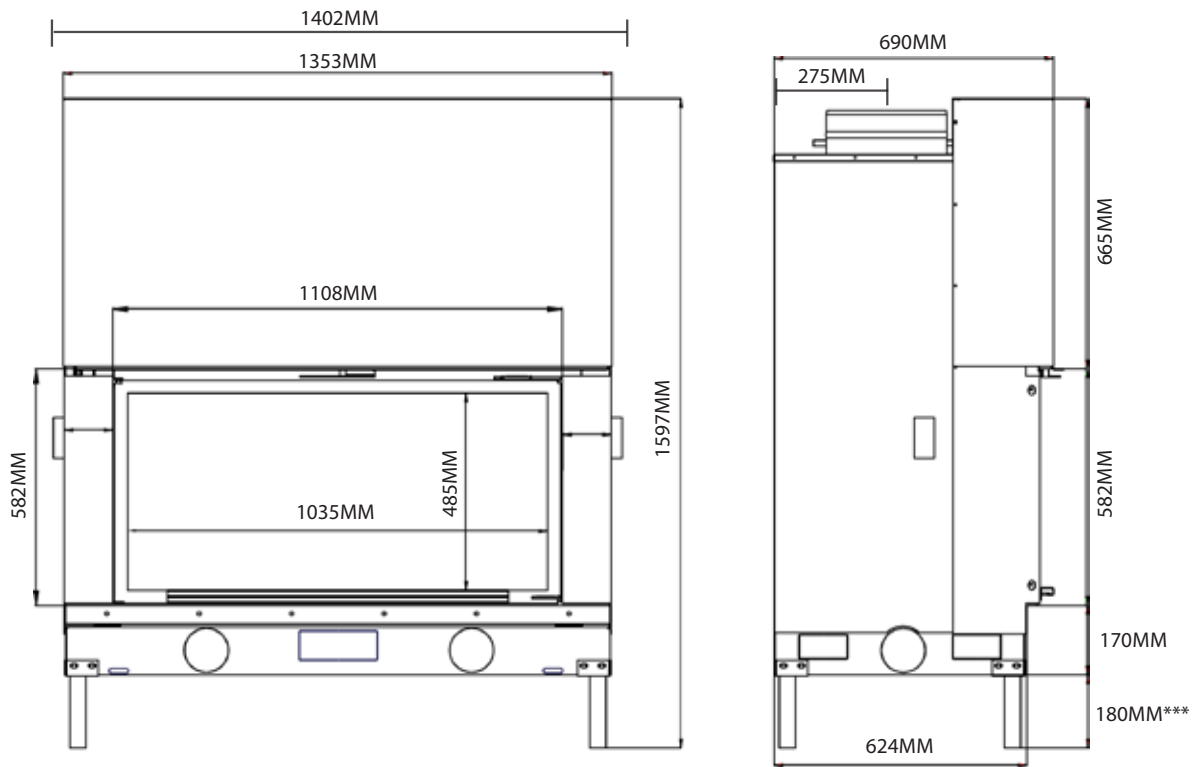

*Heating capacity of the following appliances are a guide only and refers to areas with 2.4m ceilings and 6 or more star rated buildings. Heating output may vary depending on factors such as building characteristics, quality of insulation, type of firewood used and climate zone.

**See warranty pg. 53 of the manual

*** To reduce hearth dimensions, view tables on page 15 of this manual

AXIS H1600

MATERIAL	Solid steel firebox with 60mm thick fire bricks
KW OUTPUT	25kW+
HEATING CAPACITY*	Up to 300-350m ² *
FACACE	Clean frame-less design (trim options available)
GLASS DOOR	Secure swing & lift door
MINIMUM FLUE HEIGHT	5.4m
FLUE SIZES	300mm, 350mm, 400mm
HOT AIR TRANSFER KIT	Optional extra - includes Two ducts and two registers
OUTSIDE AIR KIT	Recommended for well insulated homes
WARRANTY	10 year fire brick & 5 year firebox warranty**
WEIGHT	460kg
LEGS**	Adjustable 180mm-600mm
HEARTH DIMENSIONS***	Min 1000mm in front of any part of fireplace, 250mm on either side & 100mm thick

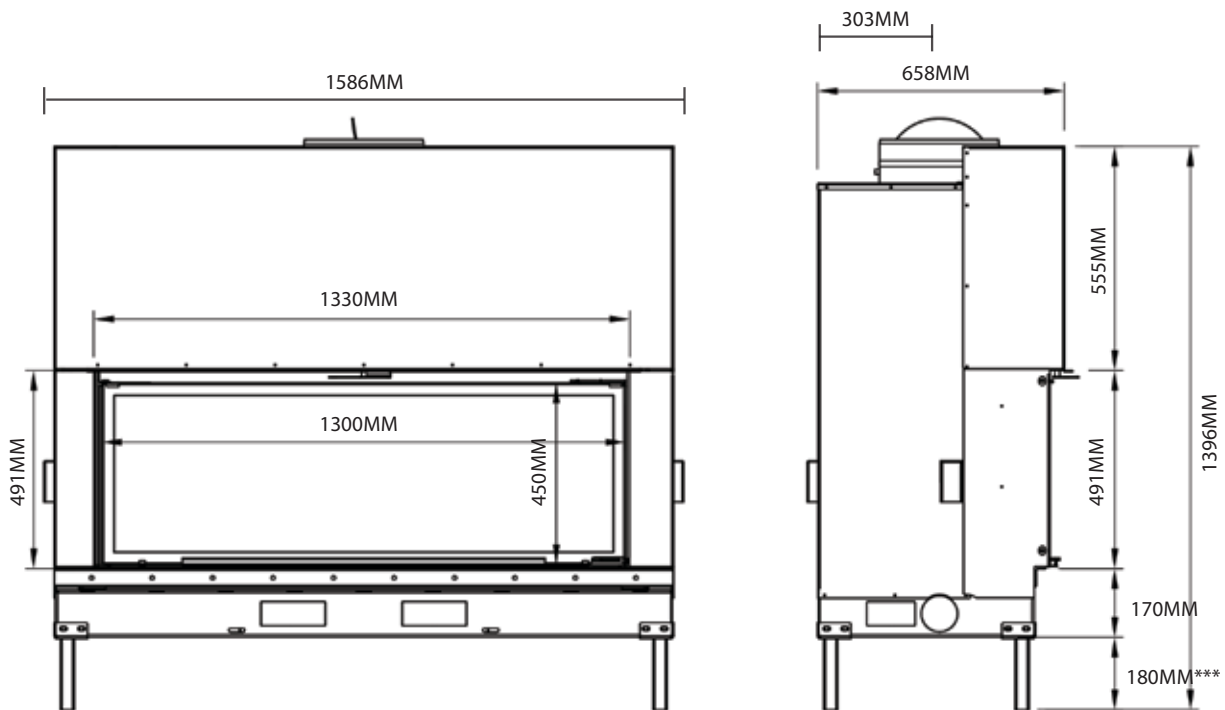

*Heating capacity of the following appliances are a guide only and refers to areas with 2.4m ceilings and 6 or more star rated buildings. Heating output may vary depending on factors such as building characteristics, quality of insulation, type of firewood used and climate zone.

**See warranty pg. 53 of the manual

*** To reduce hearth dimensions, view tables on page 15 of this manual

AXIS H1600DS

MATERIAL	Solid steel firebox with 60mm thick fire bricks
KW OUTPUT	25kW+
HEATING CAPACITY*	Up to 250m ² *
FACACE	Clean frame-less design (trim options available)
GLASS DOOR	Secure swing & lift door
MINIMUM FLUE HEIGHT	5.4m
FLUE SIZES	300mm, 350mm, 400mm
HOT AIR TRANSFER KIT	Optional extra - includes Two ducts and two registers
OUTSIDE AIR KIT	Recommended for well insulated homes
WARRANTY	10 year fire brick & 5 year firebox warranty**
WEIGHT	460kg
LEGS**	Adjustable 180mm-600mm
HEARTH DIMENSIONS***	Min 1000mm in front of any part of fireplace, 250mm on either side & 75mm thick

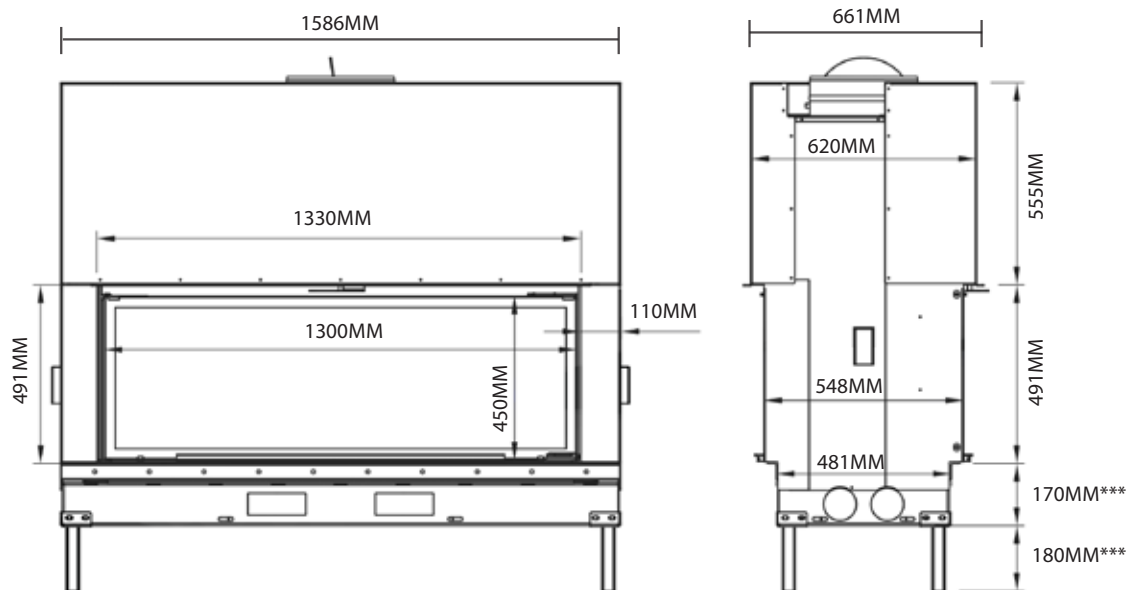

*Heating capacity of the following appliances are a guide only and refers to areas with 2.4m ceilings and 6 or more star rated buildings. Heating output may vary depending on factors such as building characteristics, quality of insulation, type of firewood used and climate zone.

**See warranty pg. 53 of the manual

*** To reduce hearth dimensions, view tables on page 15 of this manual

AXIS H1600XXL

MATERIAL	Solid steel firebox with 60mm thick fire bricks
KW OUTPUT	25kW+
HEATING CAPACITY*	Up to 350-400m ² *
FACACE	Clean frame-less design (trim options available)
GLASS DOOR	Secure swing & lift door
MINIMUM FLUE HEIGHT	5.4m
FLUE SIZES	300mm, 350mm, 400mm
HOT AIR TRANSFER KIT	Optional extra - includes Two ducts and two registers
OUTSIDE AIR KIT	Recommended for well insulated homes
WARRANTY	10 year fire brick & 5 year firebox warranty**
WEIGHT	530kg
LEGS**	Adjustable 165mm-600mm
HEARTH DIMENSIONS***	Min 1000mm in front of any part of fireplace, 250mm on either side & 100mm thick

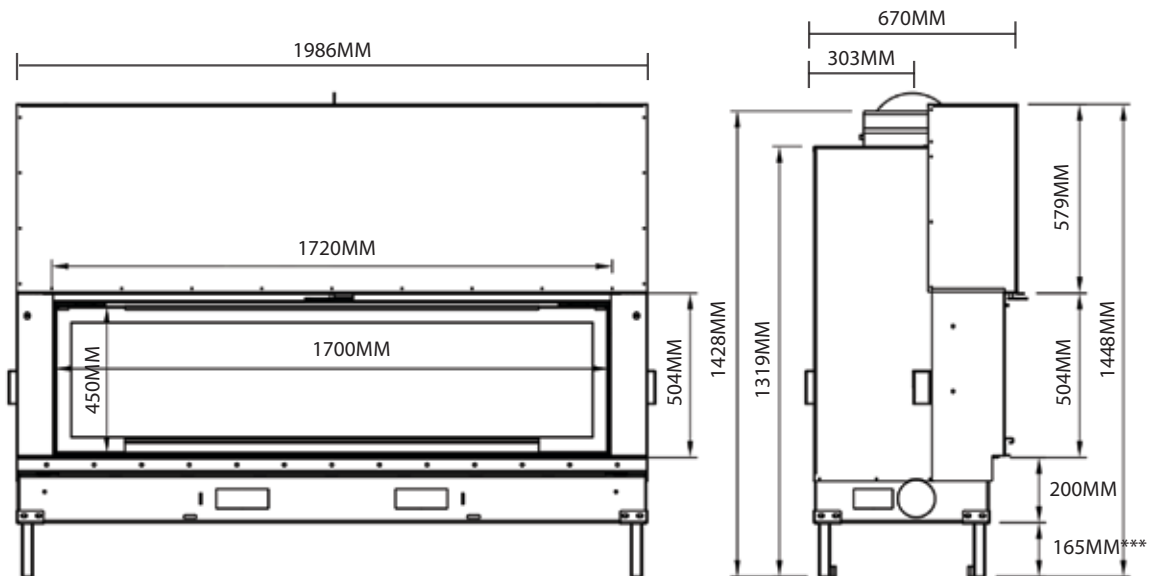

*Heating capacity of the following appliances are a guide only and refers to areas with 2.4m ceilings and 6 or more star rated buildings. Heating output may vary depending on factors such as building characteristics, quality of insulation, type of firewood used and climate zone.

**See warranty pg. 53 of the manual

*** To reduce hearth dimensions, view tables on page 15 of this manual

AXIS H1600XXL DS

MATERIAL	Solid steel firebox with 60mm thick fire bricks
KW OUTPUT	25kW+
HEATING CAPACITY*	Up to 300m ² *
FACACE	Clean frame-less design (trim options available)
GLASS DOOR	Secure swing & swing door
MINIMUM FLUE HEIGHT	5.4m
FLUE SIZES	300mm, 350mm, 400mm
HOT AIR TRANSFER KIT	Optional extra - includes Two ducts and two registers
OUTSIDE AIR KIT	Recommended for well insulated homes
WARRANTY	10 year fire brick & 5 year firebox warranty**
WEIGHT	530kg
LEGS**	Adjustable 165mm-600mm
HEARTH DIMENSIONS***	Min 1000mm in front of any part of fireplace, 250mm on either side & 75mm thick

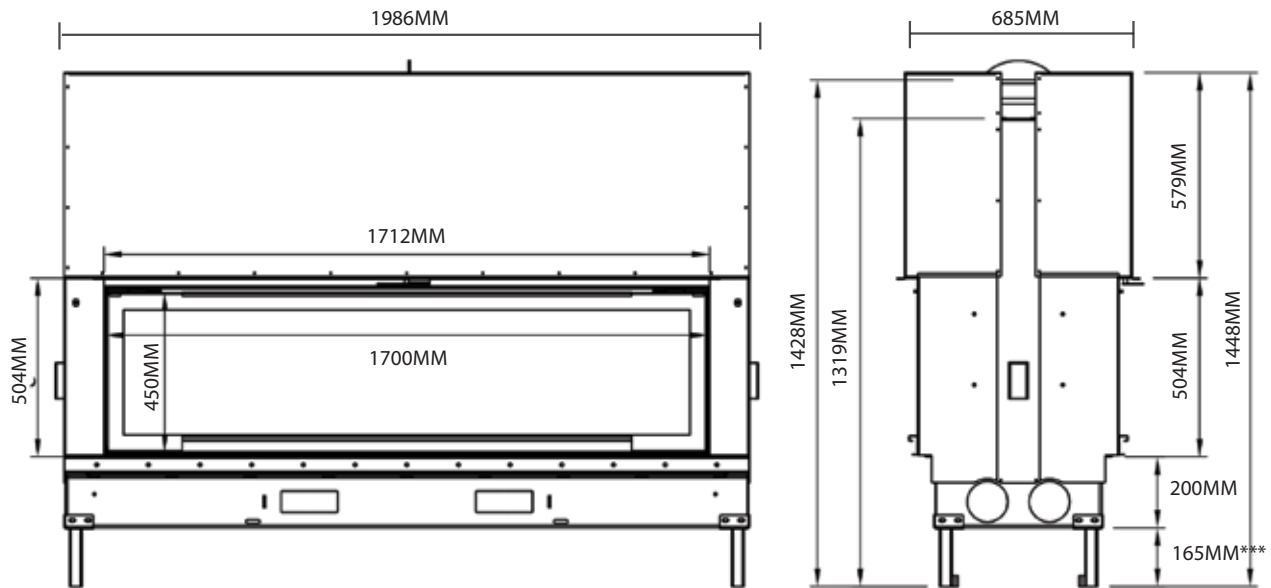

*Heating capacity of the following appliances are a guide only and refers to areas with 2.4m ceilings and 6 or more star rated buildings. Heating output may vary depending on factors such as building characteristics, quality of insulation, type of firewood used and climate zone.

**See warranty pg. 53 of the manual

*** To reduce hearth dimensions, view tables on page 15 of this manual

AXIS H1200 VLG/D

MATERIAL	Solid steel firebox with 60mm thick fire bricks
KW OUTPUT	25kW+
HEATING CAPACITY*	Up to 200m ² *
FACADE	Clean frame-less design (trim options available)
GLASS DOOR	Secure swing & lift door
MINIMUM FLUE HEIGHT	5.4m
FLUE SIZES	250mm, 300mm, 350mm
HOT AIR TRANSFER KIT	Optional extra - includes Two ducts and two registers
OUTSIDE AIR KIT	Recommended for well insulated homes
WARRANTY	10 year fire brick & 5 year firebox warranty**
WEIGHT	380kg
LEGS**	Adjustable 180mm-600mm
HEARTH DIMENSIONS***	Min 1000mm in front of any part of fireplace, 250mm on either side & 75mm thick

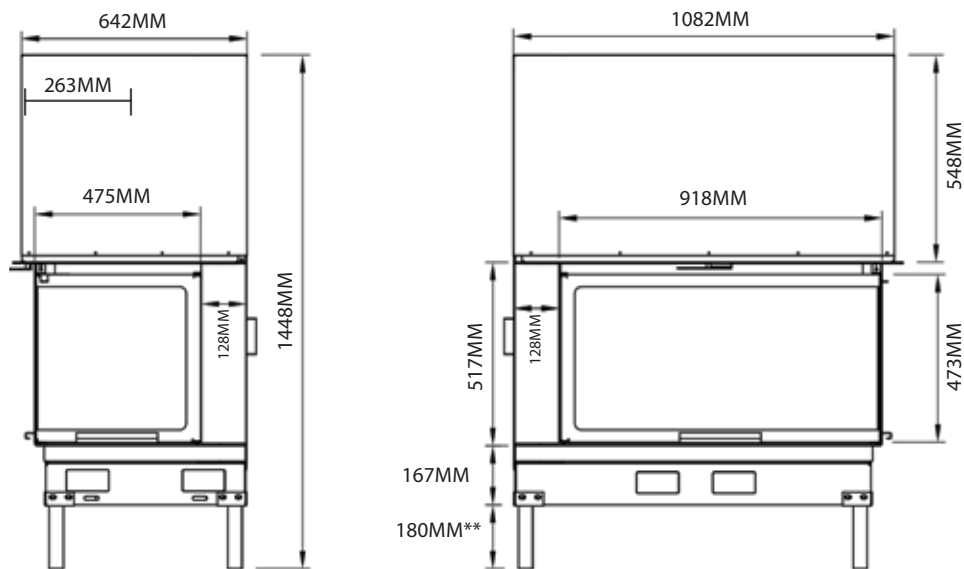

*Heating capacity of the following appliances are a guide only and refers to areas with 2.4m ceilings and 6 or more star rated buildings. Heating output may vary depending on factors such as building characteristics, quality of insulation, type of firewood used and climate zone.

**See warranty pg. 53 of the manual

*** To reduce hearth dimensions, view tables on page 15 of this manual

AXIS H1200 3V

MATERIAL	Solid steel firebox with 60mm thick fire bricks
KW OUTPUT	25kW+
HEATING CAPACITY*	Up to 200m ² *
FACACE	Clean frame-less design (trim options available)
GLASS DOOR	Secure swing & lift door
MINIMUM FLUE HEIGHT	5.4m
FLUE SIZES	250mm, 300mm, 350mm
HOT AIR TRANSFER KIT	Optional extra - includes Two ducts and two registers
OUTSIDE AIR KIT	Recommended for well insulated homes
WARRANTY	10 year fire brick & 5 year firebox warranty**
WEIGHT	380kg
LEGS**	Adjustable 180mm-600mm
HEARTH DIMENSIONS***	Min 1000mm in front of any part of fireplace, 250mm on either side & 75mm thick

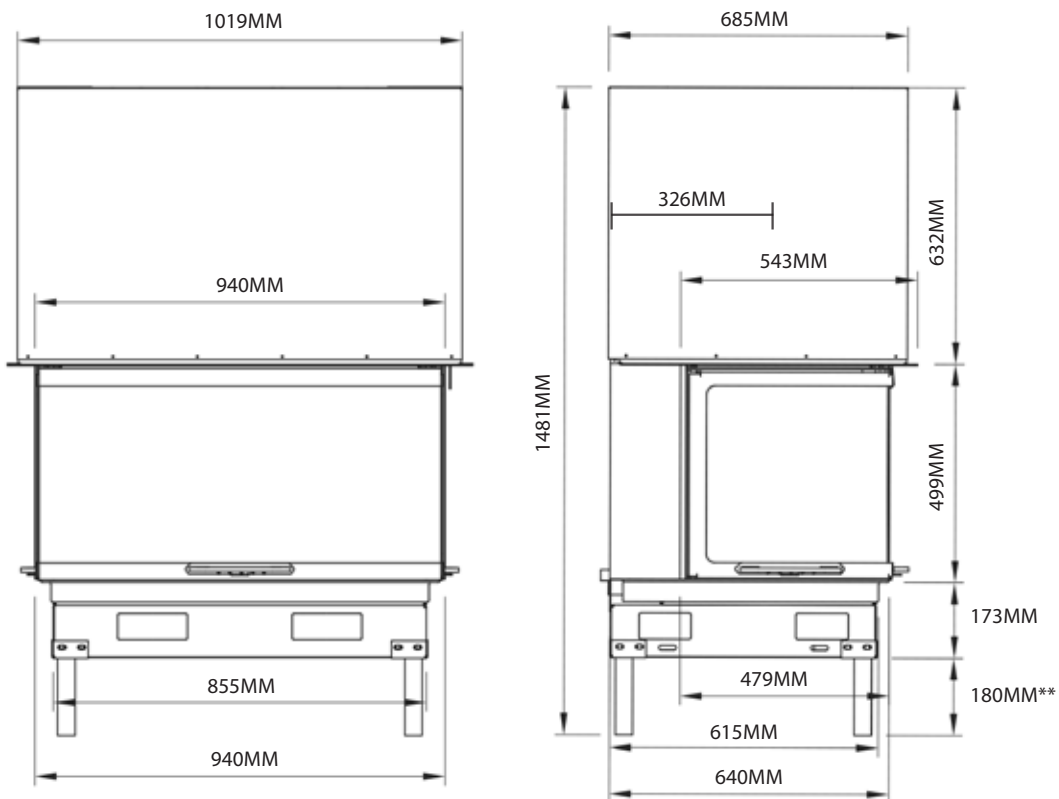

*Heating capacity of the following appliances are a guide only and refers to areas with 2.4m ceilings and 6 or more star rated buildings. Heating output may vary depending on factors such as building characteristics, quality of insulation, type of firewood used and climate zone.

**See warranty pg. 53 of the manual

*** To reduce hearth dimensions, view tables on page 15 of this manual

AXIS EPI 950

MATERIAL	Solid steel firebox with 60mm thick fire bricks
KW OUTPUT	25kW+
HEATING CAPACITY*	Up to 150-200m ² *
FACACE	Clean frame-less design (trim options available)
GLASS DOOR	Secure swing & lift door
MINIMUM FLUE HEIGHT	5.4m
FLUE SIZES	280mm, 330mm, 380mm
HOT AIR TRANSFER KIT	Optional extra - includes Two ducts and two registers
OUTSIDE AIR KIT	Recommended for well insulated homes
WARRANTY	10 year fire brick & 5 year firebox warranty**
WEIGHT	330kg
LEGS**	Adjustable 180mm-600mm
HEARTH DIMENSIONS***	Min 1000mm in front of any part of fireplace, 250mm on either side & 75mm thick

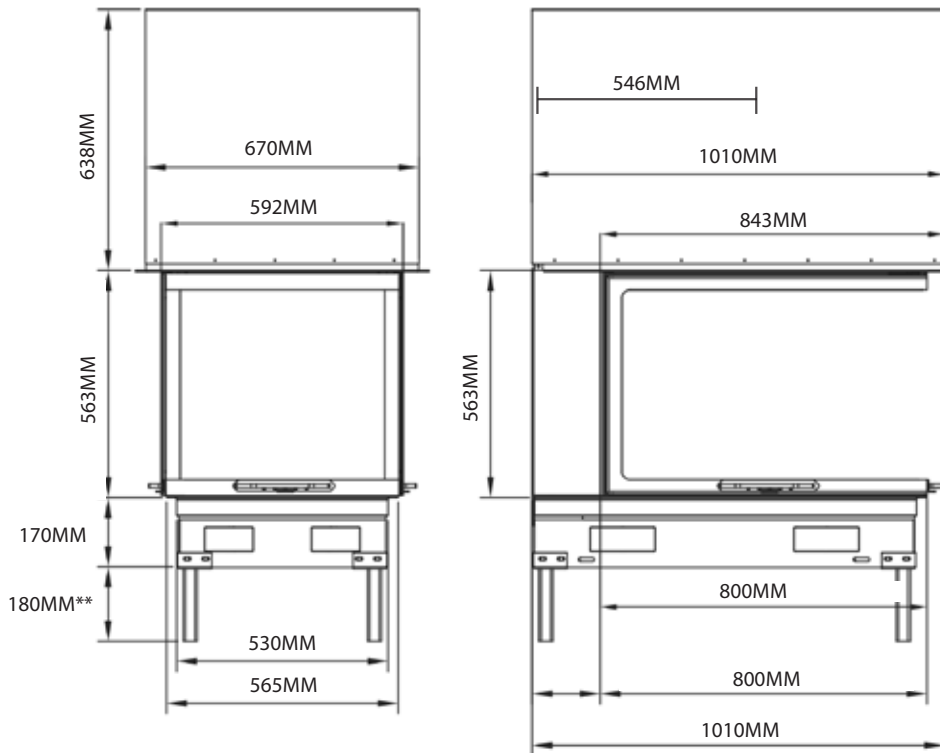

*Heating capacity of the following appliances are a guide only and refers to areas with 2.4m ceilings and 6 or more star rated buildings. Heating output may vary depending on factors such as building characteristics, quality of insulation, type of firewood used and climate zone.

**See warranty pg. 53 of the manual

*** To reduce hearth dimensions, view tables on page 15 of this manual

HEARTH REQUIREMENTS SUMMARY

Hearth Requirements (Unit Base Height Less Than 300mm)			
MODEL	WIDTH (mm)	DEPTH (mm)	THICKNESS (mm)
EPI950	2670	2010	75
H1200	1505	1000	75
H1200 3V	3020	1685	75
H1200 DS	1505	1000	75
H1200 VLD/G	2085	1645	75
H1400	1700	1000	75
H1600	1835	1000	75
H1600 DS	1835	1000	75
H1600XXL	2300	1000	75
H1600XXL DS	2300	1000	75

Hearth Requirements (Unit Base Height Greater Than 300mm)			
MODEL	WIDTH (mm)	DEPTH* (mm)	THICKNESS (mm)
EPI950	2670	2010	30
H1200	1505	1000	30
H1200 3V	3020	1685	30
H1200 DS	1505	1000	30
H1200 VLD/G	2085	1645	30
H1400	1700	1000	30
H1600	1835	1000	30
H1600 DS	1835	1000	30
H1600XXL	2300	1000	30

*Hearth depth can be reduced by elevating the fireplace, see below table for allowances

ELEVATED HEIGHT (mm)	ORIGINAL DEPTH (mm)	REDUCED DEPTH (mm)
400	1000	965
500	1000	920
600	1000	860
700	1000	780
800	1000	675
900	1000	535
1000	1000	305

COMBUSTIBLE CLEARANCES SUMMARY

Clearances To Non-Combustible Materials			
REAR & SIDES (mm)	BASE (mm)	FLUE (mm)	GRILLS* (mm)
50 (Air Gap)	150	25 (Around Triple Skin)	600 (Front) 500 (Above)

*A minimum of 4x Grills (100mm x 300mm) are required to ventilate fireplace enclosure

The above table (Combustible Clearance Summary) refers to entire H Series & EPI units; including EPI95, H1200, H1200DS, H1200VLD, H1200 VLD, H1200 VLG, H1200 3V, H1400, H1600, H1600 DS, H1600XXL & H1600XXL DS.

Note: The above information is subject to change without notice, refer to Sculpt website for most current document version.

PRELIMINARY INSTALL INFORMATION

For the installation and use of this appliance, the fitter and the user should strictly adhere to local and national regulations as well as AS/NZS 2918:2018. They should also comply with the instructions and recommendations detailed in this manual. Safety and operation of the fireplace is directly dependent thereon. The liability of the manufacturer can neither be retained nor assured following failure of installation or incorrect use which does not comply with AS/NZS 2918:2018.

As each installation is a particular case, a qualified and licensed trades professional should take all required preliminary precautions depending on the technical elements inherent to each job.

In-observance of the assembly instructions in conjunction with AS/NZS 2918:2018 entails the liability of the person who carries it out.

As a result of faulty assembly, irrational use of parts or additional components that were not supplied by the manufacturer/distributor, and/or modifying of the appliance or components will result in inferior or unsafe operation. Should this occur the manufacturer/distributor bears no liability, and will result in a null and void product warranty.

PLEASE READ PRIOR TO INSTALL

All images and diagrams in this manual are for installation reference purposes only and are not to scale. The distributor and manufacturer bears no accuracy of these images and accepts no liability. The purpose of these images and diagrams is to act as a guide in conjunction with the written components and are NOT to instruct independently. The order of these steps are a recommendation only.

It is strongly recommended that the licensed trade professional who is performing the installation of this appliance, completely read and understand all instructions in this manual prior to proceeding.

Sculpt Fireplaces Pty Ltd & Axis (Seguin Groupe) reserves the right to change these specifications without prior notice.

For reasons of quality control, some of our appliances are delivered assembled. Parts including legs and baffle plate may need to be installed on site.

EXPOSURE TO ELEMENTS

Axis fireplaces are exclusively designed as indoor heating appliances, should the fireplace (or part there of) be in contact with the outside elements including rain, snow, direct sunlight, excessive winds, etc; the damage sustained thereon will not be covered under the manufacturer or distributor warranty. Please consider prior to installing your fireplace exposed to outside elements.

ACCEPTABLE VARIANCE ALLOWANCE

Due to the production of these hand assembled and manufactured fireplaces, there is an acceptable allowance of 3-5mm variance of the unit, including the door frame. This variance in production is non-claimable under any warranties.

HEAT RESISTANT MATERIALS

Heat resistant materials must meet AS/NZS 2918:2018 clause 1.4.27 a material with an allowable service temperature of 600° Celsius or greater. Gyprock Fyrecheck is NOT a recommended heat resistant material.

It is the users duty to make themselves aware of and apply all national or more restrictive local standards and regulations (AS/NZS 2918:2018).

IMPORTANT

Prior to unpacking and installation check that the appliance has not been damaged during transport. Ensure you check the glass, the door(s), the damper operation and the door locking mechanism

Before any work is carried out, as per local and national regulations and laws, this appliance **MUST** be installed by a licensed professional as per Australian and New Zealand Standards 2918:2018.

PLEASE READ PRIOR TO INSTALL

FRESH AIR INLET, RECOMMENDED FOR ALL INSTALLATIONS

The air inlet is recommended for installation and is essential for the proper function of the appliance. The fresh combustion air inlet must be a minimum 300cm² and ideally positioned (see point A & B on diagram).

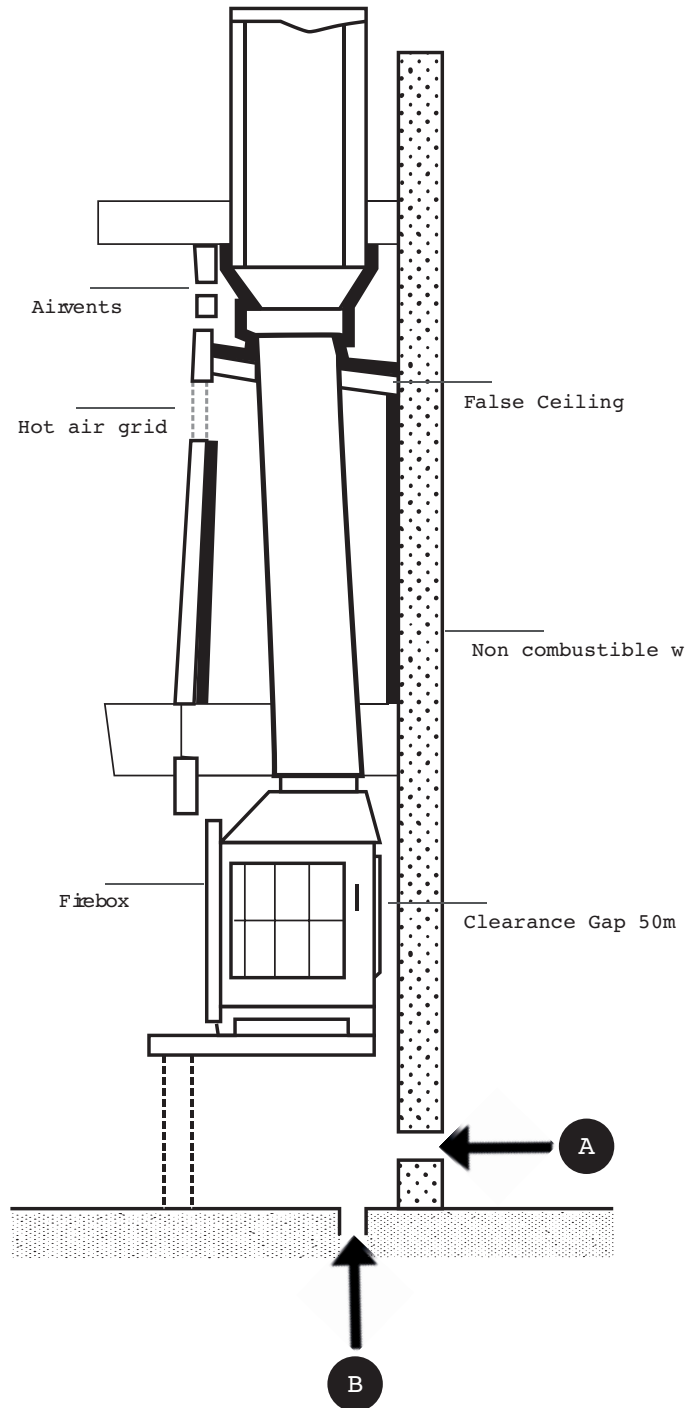
**IMPORTANT WARNING**

It is strictly forbidden to use any combustible materials (ie: wooden framing, plaster, etc) near or around this appliance. Any exception from this rule is a health and safety hazard which will result in a non-compliant installation and a void of warranties.

Electrical cables and components must not be placed in the vicinity of the appliance, as it is a fire hazard.

PLEASE READ PRIOR TO INSTALL

LEG ASSEMBLY

Before commencing any work you must ensure the structure and stability of the floor where the appliance is to be installed. Installing the legs will allow you to raise the appliance by a total of 600mm.

To streamline the installation we advise you to assemble the feet sets prior to beginning the leg assembly. Each set includes a flat angle bracket and a standard angle bracket, please check these components before proceeding with assembly.



DIAGRAM A

We advise you to cross the nuts and bolts in order to ensure a better bearing (refer to diagram A)



DIAGRAM B

The standard bracket has a space without hole which has to be turned towards the top (refer to diagram B)

PLEASE READ PRIOR TO INSTALL

OPENING LOWER VENTS - REQUIRED IF APPLIANCE IS TO INSTALLED WITHOUT LEGS

If you plan on installing the unit excluding the legs you **MUST** open ALL vents located at the bottom of the appliance prior to installation, this will ensure sufficient air flow around the unit, failure to complete this step will impact negatively on the functionality of the appliance.

To open the air vents simply apply a medium amount of pressure to the steel cover, the hatch should come free. Once completed these pieces can be discarded.

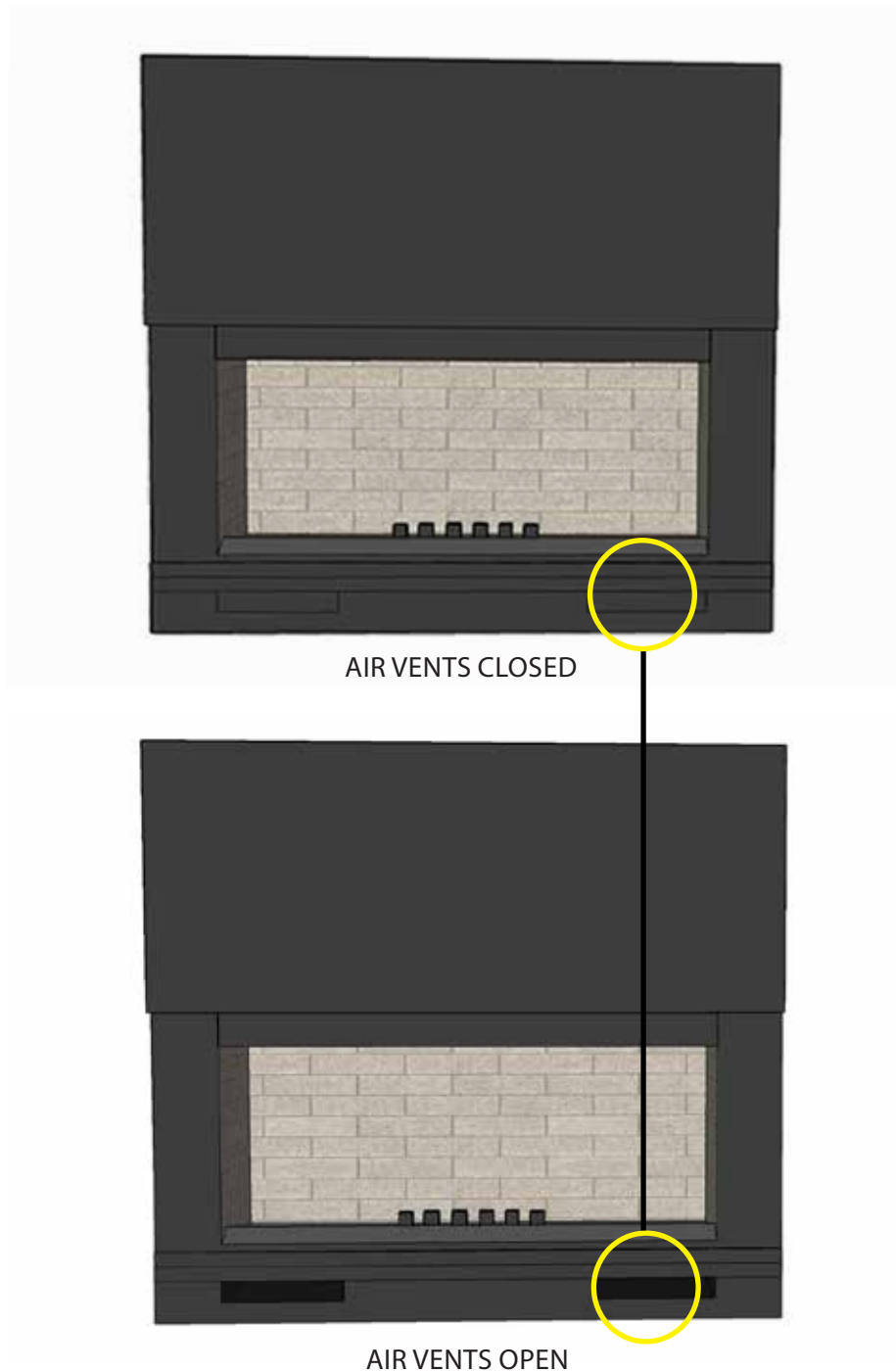

PLEASE READ PRIOR TO INSTALL

FLEXI FLUE FOR OPTIONAL OUTDOOR AIR KIT

H1200, H1200DS, H1200VLD/G, H1400, H1600, H1600 DS, H1600XXL, H1600XXLDS

The diagram pictures below details the air kit connection options for Axis appliances(H1200, H1200DS, H1200VLD/G, H1400, H1600, H1600DS, H1600XXL, H1600XXLDS), depending on your particular installation and model, your options may be limited. Carefully evaluate which options are appropriate for your installation and structure accordingly.

DOUBLE SIDE MODELS ARE ONLY MANUFACTURED WITH OPTION A FOR OUTDOOR AIR KIT CONNECTION.

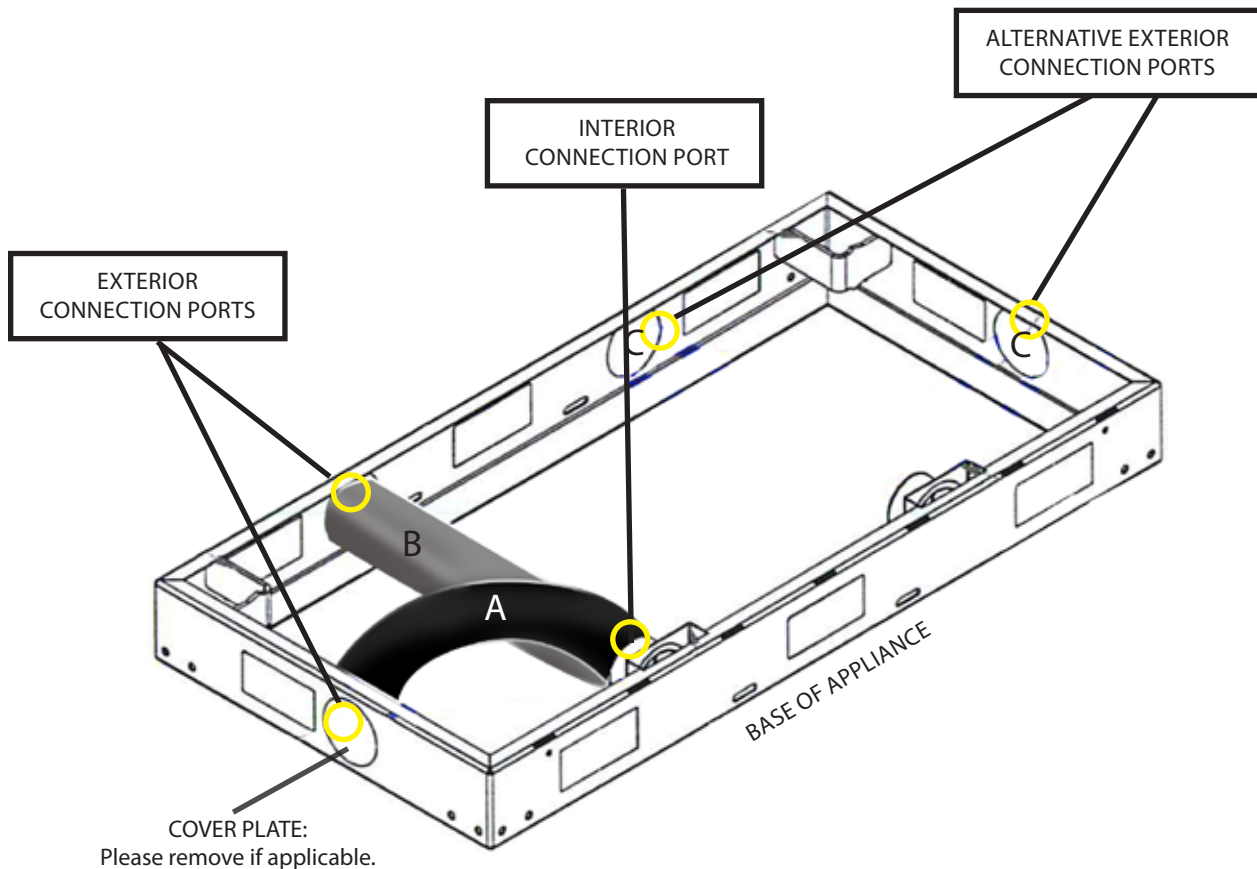

OPTION A

Interior to exterior connection for outdoor air kit duct. Please note diagram A is the only installation option for double sided appliance installation. Remove the exterior cover plate by applying medium pressure, once removed you can dispose of this cover.

OPTION C

Alternative air kit connection ports, depending on your installation circumstance, you can alternate which connection ports you utilise. Remove the exterior cover plate by applying medium pressure, once removed you can dispose of this cover.

OPTION B

Interior to exterior connection for outdoor air kit duct. Please note this connection option is only available on single sided appliances, double sided appliances do not have this connection port. Remove the exterior cover plate by applying medium pressure, once removed you can dispose of this cover.

PLEASE READ PRIOR TO INSTALL

FLEXI FLUE FOR OPTIONAL OUTDOOR AIR KIT *H1200 3V, EPI950 UNITS ONLY*

****IMPORTANT****Please ensure you have attached legs before beginning the installation of the outdoor air kit.

The diagram pictures details the air kit connection options for Axis appliances (H1200 3V and EPI950), depending on your particular installation and model your options may be limited. Carefully evaluate which options are suitable for your installation.

STEP 1.

To access the connection ports for the air kit, first remove the ash grate, then ash pan from the fireplace. You can access the ash grate and pan on the base interior of the appliance. Please refer to diagram A for reference.

STEP 2.

Locate the connection for the air kit port after removing the ash pan, remove the cover plate by applying medium pressure. Once removed you can dispose of this cover. Please refer to the diagram B for reference.

STEP 3.

Locate the outdoor air kit under the base of the appliance and fix into place, depending on your particular installation allocate the exchange accordingly, see diagram C.1 for reference. Please refer to diagram C for reference.

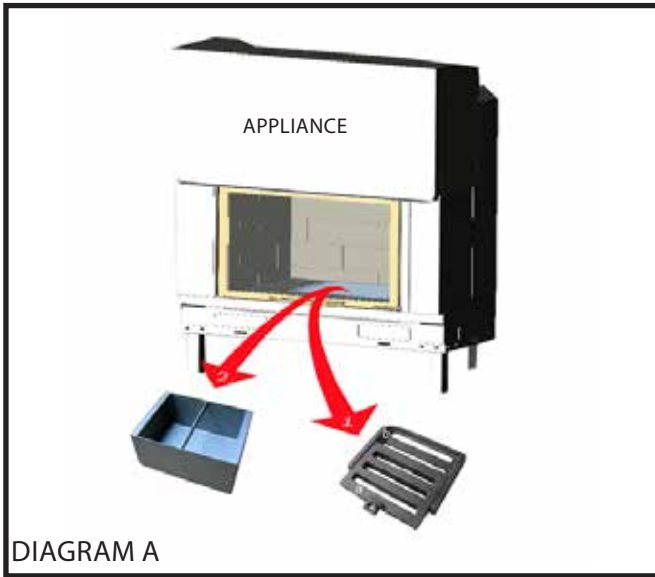

DIAGRAM A



DIAGRAM B

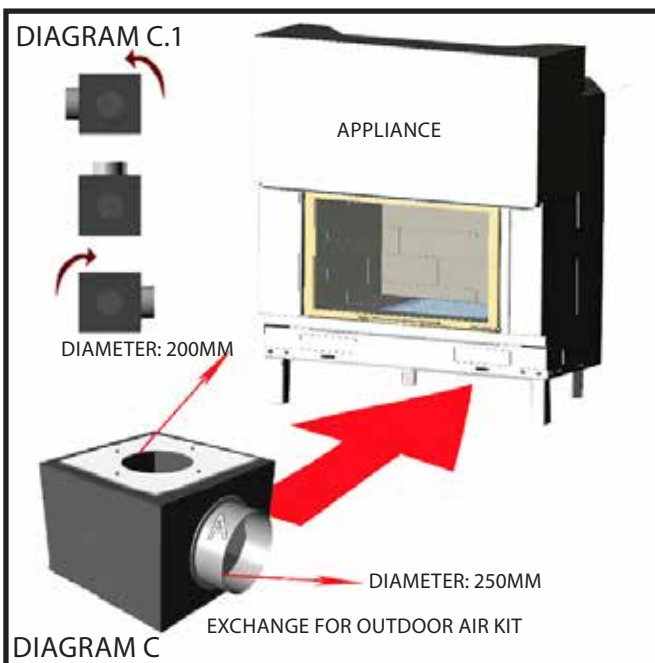
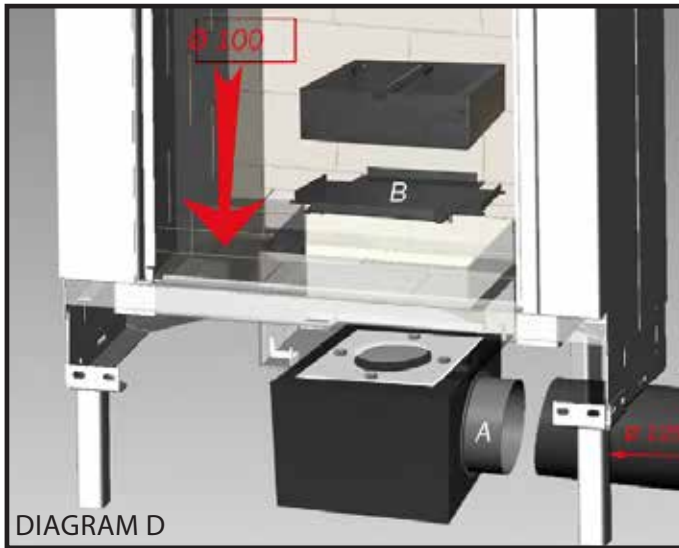

DIAGRAM C.1

DIAGRAM C



STEP 4.

Fix outdoor air kit exchange into place, utilising access located in the interior of the appliance refer to diagram E for the correct positioning of washers and screws. Once completed connect ducting to run to exterior air connection, ensure the exterior connection is protected by a vermin proof cowl. Please refer to diagram D for reference

STEP 5.

Included with the outdoor air kit is a damper and damper control, installation of this feature will assist the user in the control of the air intake for the outdoor air kit. The position of the control can be varied, we recommend assessing which location is ideal for your installation, keep in mind the user should be able to easily access this feature at all times.

Please refer to diagram F for reference

Reference application for the damper control from 0% (Closed) to 100% (Fully open). Please refer to diagram F for reference.

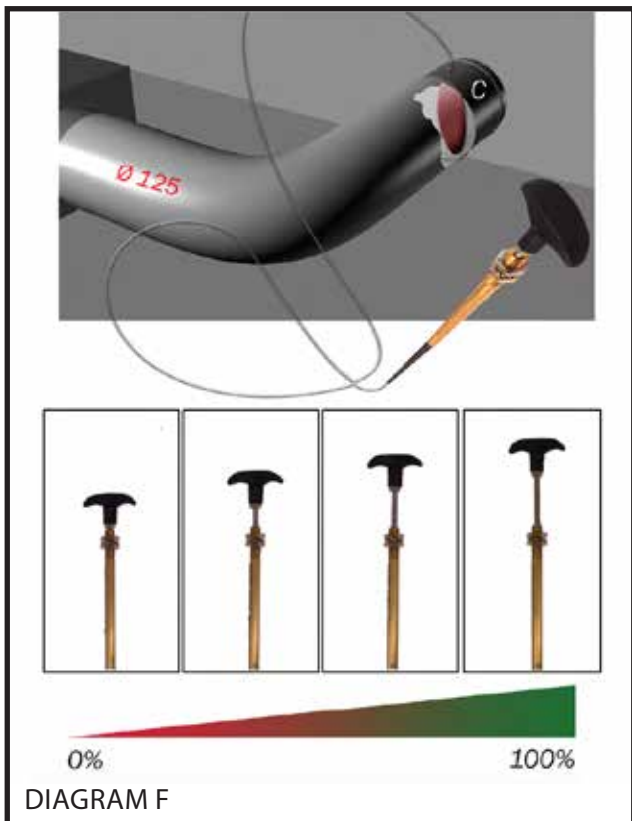
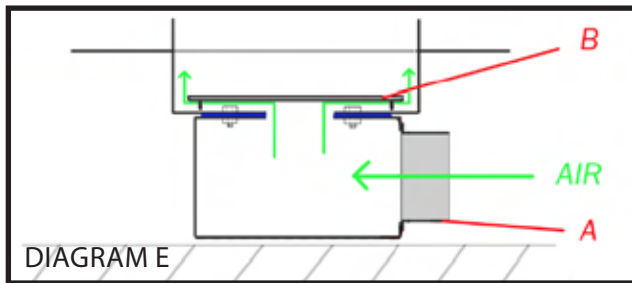

IMPORTANT

This components list details the amount of flue supplied (by the retailer) according to unit and minimum flue kit requirements. For correct use please ensure you are referring to your unit model and installation kit type. For any questions in relation to the supplied components contact your local retailer. Each unit is supplied with a ducting kit consisting of; two metal registers and two ducts (4 Zero Type: aluminium inner core, aluminium outer, poly insulated, minimum R1.0) by the retailer.

5.4M INBUILT TRIPLE SKIN FLUE KIT - AXIS H1200, H1200DS, H1200 VLG/VLD, H12003V

QUANTITY	COMPONENTS
6	900MM STAINLESS FLUE - 250MM DIAMETER
5	900MM GALVANISED FLUE - 300MM DIAMETER
5	900MM GALVANISED FLUE - 350MM DIAMETER
1	WIND RIM COWL TO SUIT

5.4M INBUILT TRIPLE SKIN FLUE KIT - AXIS H1400, H1600, H1600DS, H1600XXL, H1600XXLDS

QUANTITY	COMPONENTS
6	900MM STAINLESS FLUE - 300MM DIAMETER
5	900MM GALVANISED FLUE - 350MM DIAMETER
5	900MM GALVANISED FLUE - 400MM DIAMETER
1	WIND RIM COWL TO SUIT

5.4M INBUILT TRIPLE SKIN FLUE KIT - AXIS EPI950

QUANTITY	COMPONENTS
6	900MM STAINLESS FLUE - 280MM DIAMETER
5	900MM GALVANISED FLUE - 330MM DIAMETER
5	900MM GALVANISED FLUE - 380MM DIAMETER
1	WIND RIM COWL TO SUIT

Sculpt Fireplace Collection bears no liability to the functioning and supply of these components. Additional components required for installation are the responsibility of the retailer and(or) installer.

PLEASE READ PRIOR TO INSTALL

The diagrams depicted in this manual feature the installation procedure for the Axis H1600, while this may not be the same unit as your appliance, the process of the installation procedure across the range is standardised & should be adapted to suit your unit requirements. Depending on your appliance and installation scenario elements may vary including frame, cavity and dimensions.

No two installation follows the exact same procedure, as no two homes are alike, it is important to work with your professional installer, architect and builder to structure a custom installation that suits your scenario. Further questions regarding your appliance and its installation should be directed towards your authorised dealer.

All images and diagrams in this manual are for installation reference purposes only and are not to scale. The distributor and manufacturer bears no accuracy of these images and accepts no liability. The purpose of these images and diagrams is to act as a guide in conjunction with the written components and are NOT to instruct independently. The order of these steps are a recommendation only.

It is strongly recommended that the licensed trade professional who is performing the installation of this appliance, completely read and understand all instructions in this manual prior to proceeding.

Sculpt Fireplaces & Axis reserves the right to change these specifications without prior notice.

IMPORTANT: For possibly replacing the flue or for a technical intervention, the installation of an access hatch on the fireplace cavity is highly recommended.

ACCESS HATCH:

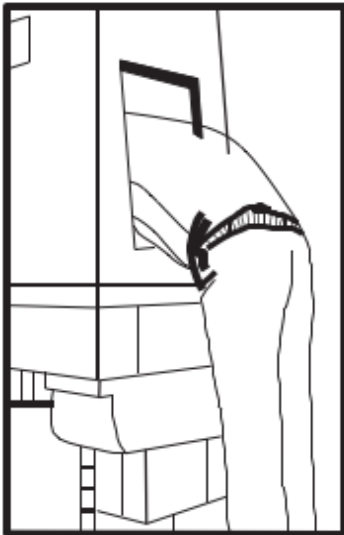



STEP 1: BASE

Lay a masonry base, minimum 100mm thick (ie. solid bricks). The base should be laid on an adequate ground supporting its weight.



STEP 2: BACK WALL

Using masonry, construct the back wall from the base to the top of the ceiling.



STEP 3: SHEET METAL LAYER (OPTIONAL STEP)

Place a thin piece of sheet metal on top of the bricks in order to level the base and safely manoeuvre the firebox.

Allow a minimum of 100mm on all sides.

5.1 MASONRY BRICK INSTALLATION

STEP 4: ASSEMBLY OF LEGS

If your installation requires the unit be elevated, install the appliance legs at this stage. Ensure the legs are adjusted and fixed at this stage.

IMPORTANT

Refer to appliance legs installation in the preliminary install section.



STEP 5: POSITIONING OF THE UNIT

Place the firebox into position on top of the sheet metal. Remember to leave a 50mm air gap on all sides of the firebox. If the unit is to be installed without legs please refer to vents in the preliminary install guide.

IMPORTANT

There **MUST** be a minimum of 150mm clearance between the base and the bottom of the unit.



***IMPORTANT* RELEASING GLASS DOOR**

Prior to continuing with installation ensure you release the glass door. First remove pins located on either side of the unit, then proceed to slowly lower the door from its factory position. You should now be able to open and close the door.

OUTDOOR AIR-KIT

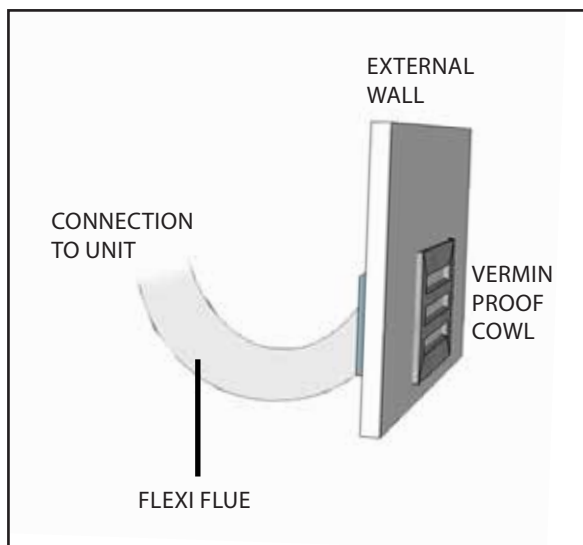

STEP 5A: OUTDOOR AIR KIT(OPTIONAL)

Any depression or lack of fresh air within the room where the fireplace is located can cause emanation of smoke to flow back into the room and the unit to run inefficiently. It is highly recommended that an Outdoor Air Kit be installed in six or more star rated homes, or any install where a mechanical device (ie. fan), takes air from the fireplace cavity & transfers it.

Place the adaptor underneath the unit and feed through the bottom and attach to the internal front adaptor. Attach the flexi flue to the adaptor and run to the external brick wall at the rear of the unit, then proceed to connect the metal vermin proof cowl onto the outside wall.

The flexi flue can be positioned either side of the adaptor in order to fit between the heater and the wall. It is not required that the flexi flue be positioned directly behind the firebox.

IMPORTANT

Refer to Air Kit installation in the preliminary install section.



STEP 6: TRIM (OPTIONAL STEP)

****IMPORTANT****

Trim must be fitted onto the firebox PRIOR to installing the front of the enclosure.

1. Manoeuvre the trim on the front of the firebox.
2. On the side of the façade of the firebox drill two holes at 4.2mm.
3. The holes must match with the slotted holes on the trim
4. Manoeuvre the trim into desired position.
5. Fix the trim into place using the screws provided (screws M5 + washers).



STEP 7: FIRST LENGTH OF FLUE

Place the first single skin length of flue (with no crimp ends) around the outside of the spigot. You may also use a heat resistance sealant (i.e. Firecork) to seal any air gaps. Prior to continuing with flue installation please continue to the next step.



STEP 8: SIDE WALLS

Using masonry (ie. clay bricks) build a layer of bricks from the base to the top of the ceiling on either side of the firebox. Remember to leave a 50mm air gap on all sides of the unit.

****IMPORTANT****

If you are installing your appliance with side vents please allow for the vent openings in the cavity exterior.

Ventilation is required on the enclosure to help with air circulation. A minimum of two air intake grills are required at the bottom and a minimum of two air out-take grills are required at the top of the masonry enclosure. All vents can be positioned either side OR the front of the masonry enclosure.

Minimum vent sizes are 100mm x 300mm with a minimum of four vents.

*All air vents must have a minimum clearance to combustibles of 600mm in front of and 500mm above the metal vent itself.

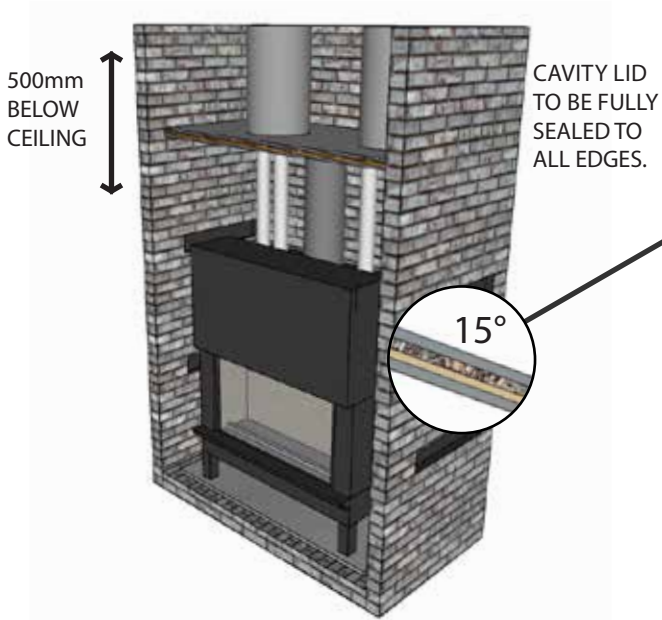

STEP 9: CAVITY LID

****IMPORTANT****

SIDE VENTS

It is highly recommended the cavity lid be installed flat to ensure sufficient air flow around the appliance if 2 vents are used.

FRONT VENTS

It is highly recommended the cavity lid be installed on an angle of 15° facing the front of the fireplace to ensure sufficient air flow around the appliance.

The cavity lid must be installed 500mm below the ceiling and be comprised of the following; minimum 3mm minimum thick steel plate for support, followed by a 12mm thick heat resistant sheet, with 1 x 25mm Rockwool sheet. A hole is to be cut in the centre of the lid in order for the single skin flue to penetrate through tightly. You may also use a heat resistance sealant (i.e. Firecork) and heat proof tape to seal any air gaps.

It is important to ensure the cavity lid is fully sealed to all edges.

STEP 10: DUCTING

The duct **MUST** be 4 Zero type (aluminium inner core, aluminium outer, poly insulated, minimum RI.0) and tested to AS 4254.1-2012. Outlet **MUST** be metal.

A typical ducting kit will comprise of two ducts and two metal registers. If not installed it will have no impact on the function of the fireplace

Cut a hole in the lid of the enclosure nearest to the room where the heat is to be transferred. Run the ducting from this hole into the roof space and locate to the room, cut out the plaster and install a metal register into the ceiling of the desire room.

****PLEASE NOTE:** A maximum duct run of 6m is recommended, A maximum of four ducts can be run off the Axis H1200, H1200DS, H1400 and EPI950 models, and a maximum of six ducts for the Axis H1600, H1600DS, H1600XXL and H1600XXLDS models.



STEP 11: DUCTING (CONTINUED)

Install the ducting to each transition piece and extend into the roof space and to the desired room(s). Cut a hole in the ceiling and install a metal register into the ceiling of the room the vents will be allocated in. If more ducts are required additional components and duct design is to be provided by the retailer or installer.



STEP 12: TRIPLE SKIN FLUE

Triple skin flue is to then be continued on top of the cavity lid. The lower end of the triple skin casing shall be close fitting against the lid and the outer casing must be ventilated. Air vents on the first length of triple skin flue must be cut, or manufactured into the bottom length of the flue as per testing.

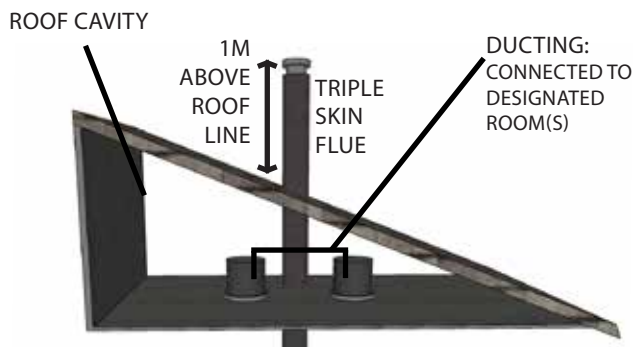

STEP 13: FLUE INSTALLATION

The triple skin flue will then be continued into the roof cavity and extended above the roof line as per AS/NZ 2918:2018.

There must be a minimum of 25mm clearance around the outer triple skin flue. The flue must extend a minimum of 1m above the roof line and have a 3m diameter clearance from the top of the cowl to any objects in a horizontal direction.

****IMPORTANT****

Please note the flue should not include more than two 45° bends. The angle of these bends cannot exceed more than 45° and can have no more than one length of 900mm flue between them.

STEP 14: VENTILATION

****IMPORTANT****

Ventilation is required to assist with air circulation. A minimum of two air intake grills are required at the bottom and a minimum of two air out-take grills are required at the top of the masonry enclosure. All vents can be positioned either side OR the front of the masonry enclosure.

Minimum vent sizes are 100mm x 300mm with a minimum quantity of four*

*The vent sizes and quantity can be adapted and changed BUT they must meet the minimum ventilation requirements as specified above. For custom made vents please contact your nearest dealer. ALL VENTS MUST NOT BE PLASTIC OR MANUFACTURED USING A COMBUSTIBLE MATERIAL.

*All air vents must have a minimum clearance to combustibles of 600mm in front and 300mm above the metal vent itself.



STEP 15: FRONT OF THE ENCLOSURE

The front of the enclosure can now be fitted with masonry bricks or a layer of 12mm minimum thick heat resistant sheet. It is recommended an air gap allowance of 50mm is provided in front of the appliance.



STEP 16: HEARTH (FLOOR PROTECTOR)

The hearth must be constructed from masonry or a non combustible material and must extend 500mm in front of any part of the appliance, 250mm on either side of the appliance and have a thickness of 100mm.



STEP 17: BAFFLE PLATE

Ensure the baffle plate sits securely in place, this step is vitally important for the safe use and proper functioning of the appliance.



STEP 1: BASE

Lay a masonry base, minimum 100mm thick (ie. solid bricks). The base should be laid on an adequate ground supporting its weight.



STEP 2: BACK WALL

Using masonry, construct the back wall from the base to the top of the ceiling.

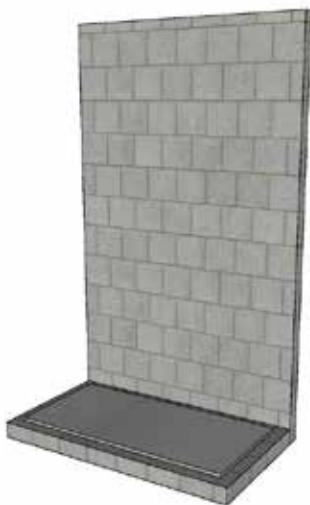

STEP 3: SHEET METAL LAYER (OPTIONAL STEP)

Place a thin piece of sheet metal on top of the bricks in order to level the base and safely manoeuvre the firebox.

Allow a minimum of 100mm on all sides.

5.2 HEBEL INSTALLATION

STEP 4: ASSEMBLY OF LEGS

If your installation requires the unit be elevated install the appliance legs at this stage, ensure the legs are adjusted and fixed.

****IMPORTANT****

Please refer to appliance legs installation in the preliminary install section.



STEP 5: POSITIONING OF THE UNIT

Place the firebox into position on top of the sheet metal. If the unit is to be installed without legs, remember to leave a 50mm air gap on all sides of the firebox.

****IMPORTANT****

There **MUST** be a minimum of 150mm clearance between the base and the bottom of the unit.

Please refer to 'Opening Lower Vents' in the preliminary install section.



***IMPORTANT* RELEASING GLASS DOOR**

Prior to continuing with installation ensure you release the glass door. First remove pins located on either side of the unit, then proceed to slowly lower the door from its factory position. You should now be able to open and close the door.

OUTDOOR AIR KIT

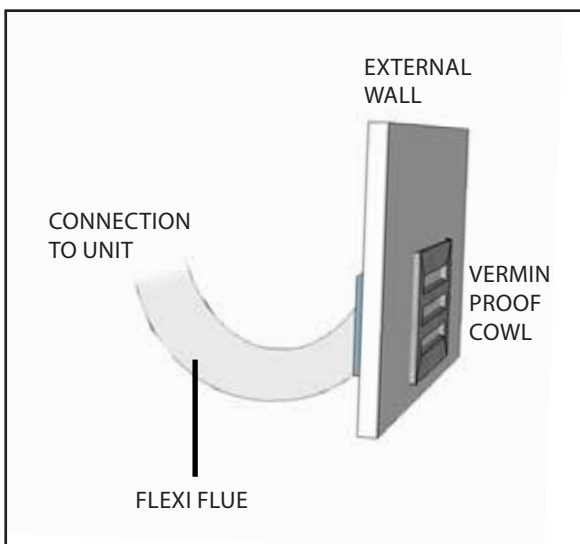

STEP 6: OUTDOOR AIR KIT(OPTIONAL)

Any depression or lack of fresh air within the room where the fireplace is located can cause emanation of smoke to flow back into the room and the unit to run inefficiently. It is highly recommended that an Outdoor Air Kit be installed in six or more star rated homes, or any install where a mechanical device (ie. fan), takes air from the fireplace cavity & transfers it.

Place the adaptor underneath the unit and feed through the bottom and attach to the internal front adaptor. Attach the flexi flue to the adaptor and run to the external brick wall at the rear of the unit, then proceed to connect the metal vermin proof cowl onto the outside wall.

The flexi flue can be positioned either side of the adaptor in order to fit between the heater and the wall. It is not required that the flexi flue be positioned directly behind the firebox.

IMPORTANT

Please refer to Air Kit installation in the preliminary install guide section.



STEP 7: TRIM (OPTIONAL STEP)

****IMPORTANT****

Trim must be fitted onto the firebox PRIOR to installing the front of the enclosure.

1. Manoeuvre the trim on the front of the firebox
2. On the side of the façade of the firebox drill two holes at 4.2mm.
3. The holes must match with the slotted holes on the trim
4. Manoeuvre the trim into desired position.
5. Fix the trim into place using the screws provided (screws M5 + washers).



STEP 8: FIRST LENGTH OF FLUE

Place the first single skin length of flue (with no crimp ends) around the outside of the spigot. You may also use a heat resistance sealant (i.e. Firecork) to seal any air gaps. Prior to continuing with flue installation please continue to the next step.

STEP 9: CAVITY LID & VENTS

****IMPORTANT****

SIDE VENTS

It is highly recommended the cavity lid be installed flat to ensure sufficient air flow around the appliance.

FRONT VENTS

It is highly recommended the cavity lid be installed on an angle of 15° facing the front of the fireplace, to ensure sufficient air flow around the appliance.

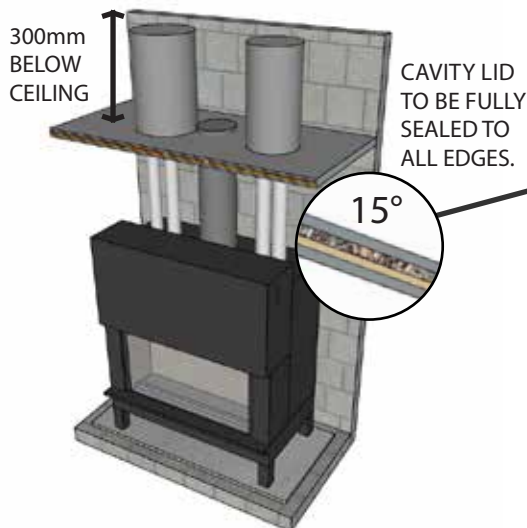

The cavity lid must be installed 300mm below the ceiling and be comprised of the following; minimum 3mm thick steel plate for support, followed by a 12mm thick heat resistant sheet, with 1 x 25mm Rockwool sheet. A hole is to be cut in the centre of the lid in order for the single skin flue to penetrate through tightly. You may also use a heat resistance sealant (i.e. Firecork) and heat proof tape to seal any air gaps. It is important to ensure the cavity lid is fully sealed to all edges.

STEP 10: DUCTING

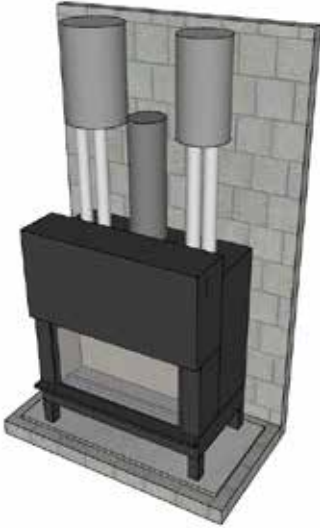

The duct **MUST** be 4 Zero type (aluminium inner core, aluminium outer, poly insulated, minimum RI.0) and tested to AS 4254.1-2012. Outlet **MUST** be metal.

This unit has been supplied with a ducting kit (consisting of two ducts and two metal registers), while it is highly recommended that it be installed, if not installed it will have no implication on the functioning of the unit.

Cut a hole in the lid of the enclosure nearest to the room where the heat is to be transferred. Run the ducting from this hole into the roof space and locate to the room, cut out the plaster and install a metal register into the ceiling of the desired room.

****PLEASE NOTE:** A maximum duct run of 6m is recommended, A maximum of four ducts can be run off the Axis H1200, H1200DS, H1400 and EPI950 models, and a maximum of six ducts for the Axis H1600, H1600DS, H1600XXL and H1600XXLDS models.

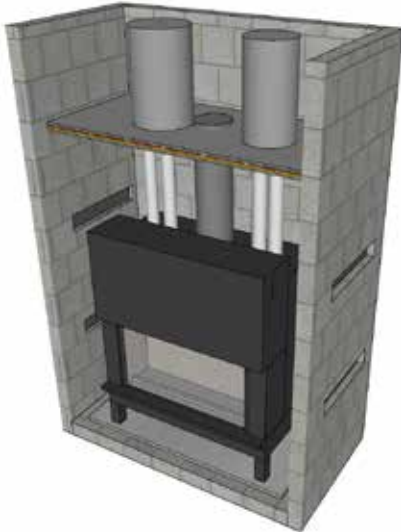

STEP 11: SIDE WALLS

Using a minimum of 100mm Hebel, build a layer of bricks from the base to the top of the ceiling on either side of the enclosure.

SIDE VENTS

If you are installing your appliance with side vents, ensure you leave the necessary gaps when constructing the side walls. (Please refer to step 9 & 15)



STEP 12: DUCTING CONTINUED...

Install the ducting to each transition piece and extend into the roof space and to the desired room(s). Cut a hole in the ceiling and install a metal register into the ceiling of the room the vents will be allocated in. If more ducts are required additional components and duct design is to be provided by the retailer or installer.

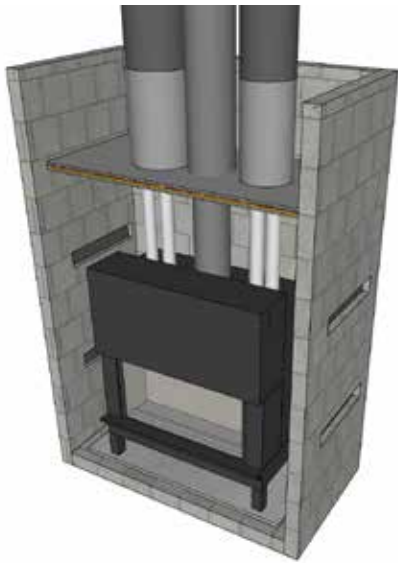

STEP 13: TRIPLE SKIN FLUE

Triple skin flue is to then be continued above the cavity lid. The lower end of the triple skin casing shall be close fitting against the lid and the outer casing must be ventilated. Air vents on the first length of triple skin flue must be cut by the installer.

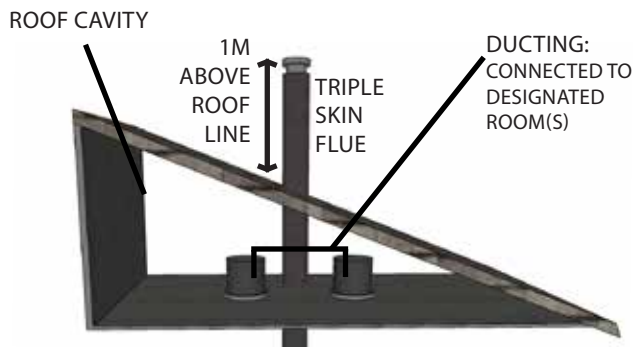

STEP 14: FLUE INSTALLATION

The triple skin flue will then be continued into the roof cavity and extended above the roof line as per AS/NZ 2918:2018.

There must be a 50mm clearance around the outer triple skin flue. The flue must extend a minimum 1m above the roof line and have a 3m diameter clearance from the top of the cowl to any object in a horizontal direction.

****IMPORTANT****

Please note the flue should not include more than two 45° bends. The angle of these bends cannot exceed more than 45° and can have no more than one length of 900mm flue between them.

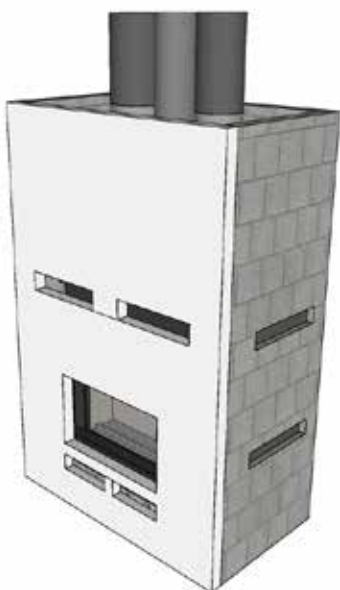

STEP 15: VENTILATION

Using Hebel build a layer of bricks from the base to the top of the ceiling on either side of the enclosure.

****IMPORTANT****

Ventilation is required on the enclosure to help with air circulation. A minimum of two air intake grills are required at the bottom and a minimum of two air out-take grills are required on top of the masonry enclosure (2X inflow 2X outflow). All vents can be positioned either side OR the front of the masonry enclosure. ALL vents must adhere to the minimum vent size of 600cm².

Minimum vent sizes are 100mm x 300mm with a minimum quantity of four*

*The vent sizes and quantity can be adapted and changed BUT they must meet the minimum ventilation requirements as specified above. For custom made vents please contact your nearest dealer. ALL VENTS MUST NOT BE PLASTIC OR COMBUSTIBLE.

*All air vents must have a minimum clearance to combustibles of 600mm in front and 500mm above the metal vent itself.

STEP 16: FRONT OF THE ENCLOSURE

Using hebel, build a layer of bricks from the base to the top of the ceiling on either side of the enclosure. Fit a layer of 12mm minimum thick heat resistant sheet on the exterior and finish.

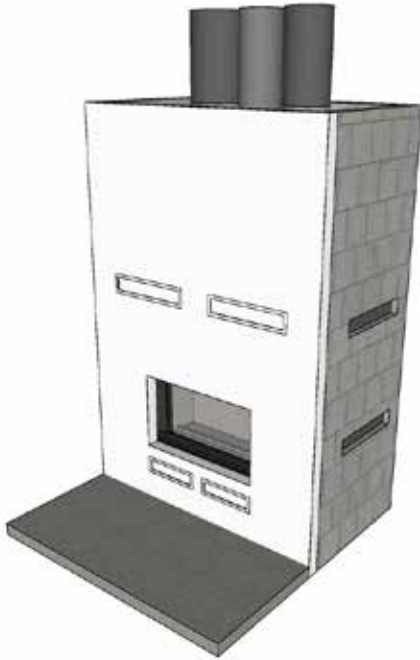

STEP 17: HEARTH (FLOOR PROTECTOR)

The hearth must be constructed from masonry or a non combustible material and must extend 500mm in front of any part of the appliance, 250mm on either side and have a thickness of 100mm.

STEP 18: BAFFLE PLATE

Ensure the baffle plate sits securely in place, this step is vitally important for the safe use and proper functioning of the appliance.



STEP 1: BASE

Lay a masonry base, minimum 150mm thick (ie. solid bricks). The base should be laid on an adequate ground supporting its weight.



STEP 2: SHEET METAL LAYER (OPTIONAL STEP)

Place a thin piece of sheet metal on top of the bricks in order to level the base and safely manoeuvre the firebox.

Allow a minimum of 100mm on all sides.

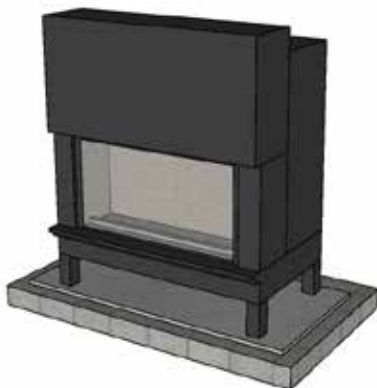

STEP 3: ASSEMBLY OF LEGS

If your installation requires the unit be elevated install the appliance legs at this stage, ensure the legs are adjusted and fixed at this stage.

****IMPORTANT****

Please refer to appliance legs installation in the preliminary install section.

STEP 4: POSITIONING OF THE UNIT

Place the firebox into position on top of the sheet metal. Remember to leave a 25mm air gap on all sides of the firebox. If the unit is to be installed without legs, please refer to opening lower vents in the preliminary install guide.

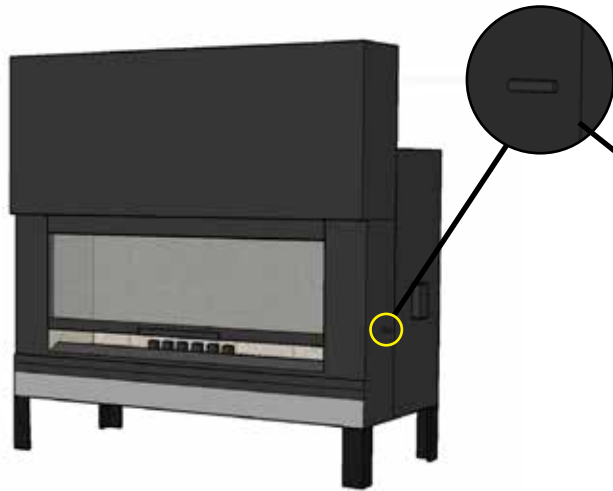

IMPORTANT RELEASING GLASS DOOR

Prior to continuing with the installation ensure you release the glass door. First remove pins located on either side of the unit, then proceed to slowly lower the door from its factory position. You should now be able to open and close the door.

OUTDOOR AIR KIT

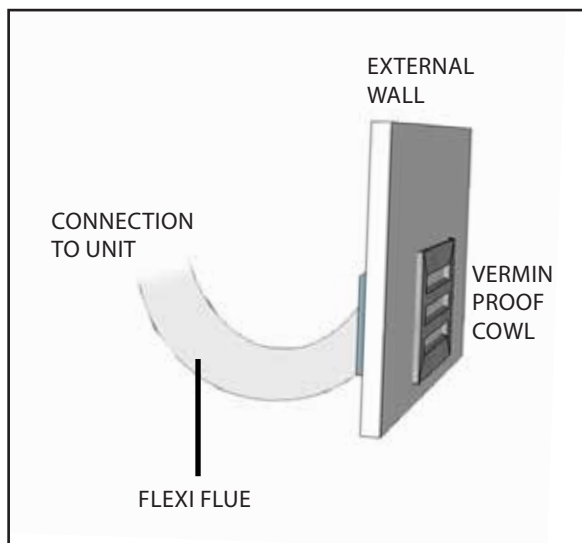

STEP 5: OUTDOOR AIR KIT (OPTIONAL)

Any depression or lack of fresh air within the room where the fireplace is located can cause emanation of smoke to flow back into the room and the unit to run inefficiently. It is highly recommended that an Outdoor Air Kit be installed in six or more star rated homes, or any install where a mechanical device (ie. fan), takes air from the fireplace cavity & transfers it.

Place the adaptor underneath the unit and feed through the bottom and attach to the internal front adaptor. Attach the flexi flue to the adaptor and run to the external brick wall at the rear of the unit, then proceed to connect the metal vermin proof cowl onto the outside wall.

The flexi flue can be positioned either side of the adaptor in order to fit between the heater and the wall. It is not required that the flexi flue be positioned directly behind the firebox.

IMPORTANT

Please refer to the Outdoor Air Kit installation in the preliminary install guide section.



STEP 6: TRIM (OPTIONAL STEP)

****IMPORTANT****

Trim must be fitted onto the firebox **PRIOR** to installing the front of the enclosure.

1. Manoeuvre the trim on the front of the firebox.
2. On the side of the façade of the firebox drill two holes at 4.2mm.
3. The holes must match with the slotted holes on the trim.
4. Manoeuvre the trim into desired position.
5. Fix the trim into place using the screws provided (screws M5 + washers).

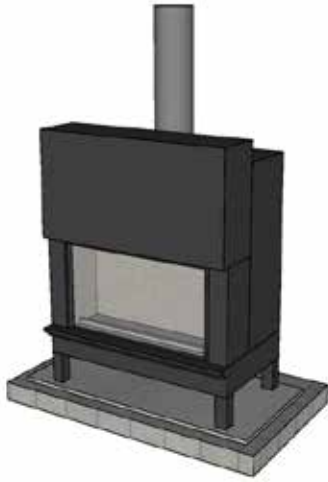

STEP 7: FIRST LENGTH OF FLUE

Place the first single skin length of flue (with no crimp ends) around the outside of the spigot. You may also use a heat resistance sealant (i.e. Firecork) to seal any air gaps. Before installing the remaining lengths of flue. Prior to continuing with flue installation please continue to the next step.



STEP 8: COMBUSTIBLE MATERIAL (if required)

Where there is a combustible surface (ie: wall, shelves, television, etc) you must use masonry to construct a wall from the base to the top of the ceiling.



STEP 9: DUCTING

The duct **MUST** be 4 Zero type (aluminium inner core, aluminium outer, poly insulated, minimum R1.0) and tested to AS 4254.1-2012. Outlet **MUST** be metal.

This unit has been supplied with a ducting kit (consisting of two ducts and two metal registers), while it is highly recommended that it be installed, if not installed it will have no implication on the functioning of the unit.

Cut a hole in the lid of the enclosure nearest to the room where the heat is to be transferred. Run the ducting from this hole into the roof space and locate to the room, cut out the plaster and install a metal register into the ceiling of the desire room.

****PLEASE NOTE:** A maximum duct run of 6m is recommended, A maximum of four ducts can be run off the Axis H1200, H1200DS, H1400 and EPI950 models, and a maximum of six ducts for the Axis H1600, H1600DS, H1600XXL and H1600XXLDS models.

6. INBUILT INTO ISLAND WALL

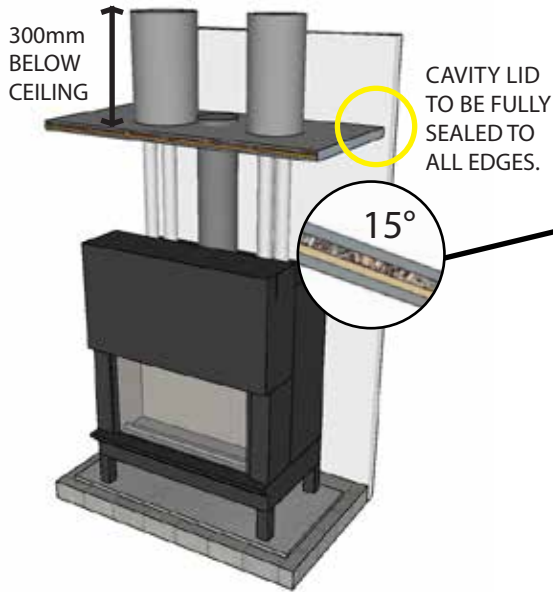

STEP 10: CAVITY LID

****IMPORTANT**** SIDE VENTS

It is highly recommended the cavity lid be installed flat to ensure sufficient air flow around the appliance.

FRONT VENTS

It is highly recommended the cavity lid be installed on an angle of 15° facing the front of the fireplace, to ensure sufficient air flow around the appliance.

The cavity lid must be installed 300mm below the ceiling and be comprised of the following; minimum 3mm thick steel plate for support, followed by a 12mm thick heat resistant sheet, with 1 x 25mm Rockwool sheet. A hole is to be cut in the centre of the lid in order for the single skin flue to penetrate through tightly. You may also use a heat resistance sealant (i.e. Firecork) and heat proof tape to seal any air gaps. It is important to ensure the cavity lid is fully sealed to all edges.

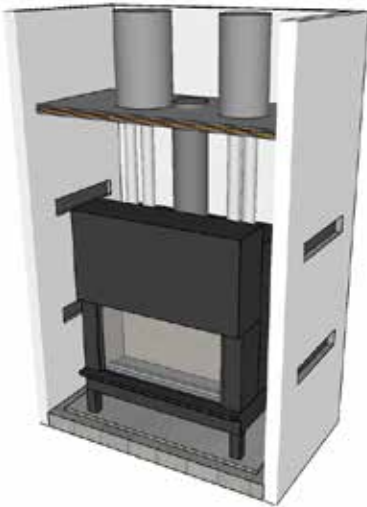

STEP 11: SIDE WALLS

Attach a heat resistant material from the base to the top of the ceiling on the sides of the enclosure.

SIDE VENTS

If you are installing your appliance with side vents, ensure you leave the necessary gaps when constructing the side walls. (Refer to step 12 & 18)

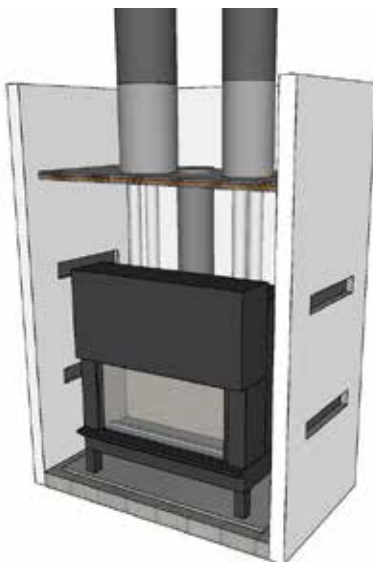

STEP 12: DUCTING CONTINUED...

Install the ducting to each transition piece and extend into the roof space and to the desired room(s). Cut a hole in the ceiling and install a metal register into the ceiling of the room the vents will be allocated in. If more ducts are required additional components and duct design is to be provided by the retailer or installer.

6. INBUILT INTO ISLAND WALL

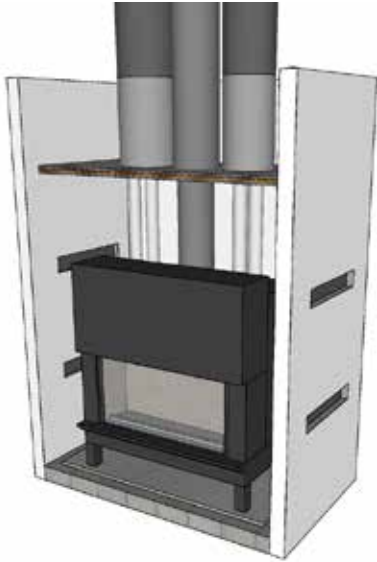

STEP 13: TRIPLE SKIN FLUE

Triple skin flue is to then be continued above the cavity lid. The lower end of the triple skin casing shall be close fitting against the lid and the outer casing must be ventilated. Air vents on the first length of triple skin flue must be cut by the installer.

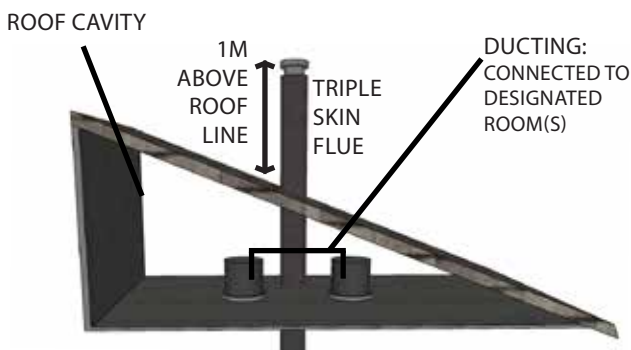

STEP 14: FLUE INSTALLATION

The triple skin flue will then be continued into the roof cavity and extended above the roof line as per AS/NZ 2918:2018.

There must be a 25mm clearance around the outer triple skin flue. The flue must extend a minimum of 1m above the roof line and have a 3m diameter clearance from the top of the cowl to any objects in a horizontal direction.

****IMPORTANT****

Please note the flue should not include more than two 45° bends. The angle of these bends cannot exceed more than 45° and can have no more than one length of 900mm flue between them.

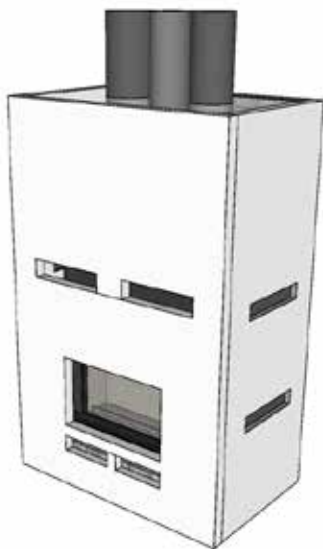

STEP 15: FRONT

Attach a minimum thickness of 100mm Hebel from the base to the top of the ceiling on the front of the enclosure.

STEP 16: VENTILATION

****IMPORTANT****

Ventilation is required on the enclosure to help with air circulation. A minimum of two air intake grills are required at the bottom and a minimum of two air out-take grills are required on top of the masonry enclosure (2X inflow 2X outflow). All vents can be positioned either side OR the front of the masonry enclosure. ALL vents must adhere to the minimum vent size of 600cm².

Minimum vent sizes are 100mm x 300mm with a minimum quantity of four*

*The vent sizes and quantity can be adapted and changed BUT they must meet the minimum ventilation requirements as specified above. For custom made vents please contact your nearest dealer. ALL VENTS MUST NOT BE PLASTIC OR COMBUSTIBLE.

*All air vents must have a minimum clearance to combustibles of 600mm in front and 500mm above the metal vent itself.

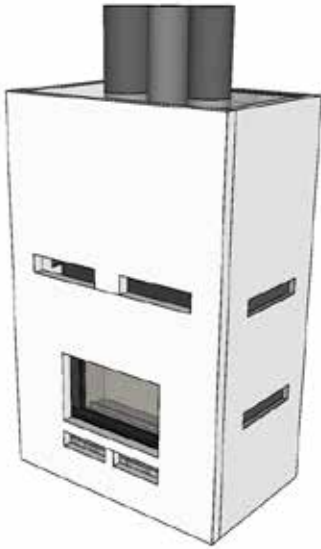

STEP 17: HEARTH (FLOOR PROTECTOR)

The hearth must be constructed from masonry or a non combustible material, and must extend 500mm or 600mm in front of any part of the appliance, 250mm on either side and a thickness of 75mm.

STEP 18: BAFFLE PLATE

Ensure the baffle plate sits securely in place, this step is vitally important for the safe use and proper functioning of the appliance.

APPLIANCE DETAILS

TRIPLE BURN SYSTEM

LARGE GLASS VIEWING AREA

The large glass viewing area not only ensures great view of the fireplace, but assists in radiation of heat.

DAFS

Axis inbuilt wood fireplaces are equipped with DAFS (Double Air Flow System) technology, this allows oxygen to be injected into the combustion chamber.

The advantages the double air flow system include; reduced creosote build up, cleaner glass and total combustion of firewood.

FIRE-BRICKS

These inbuilt Axis fireplaces are internally lined with 60mm thick refractory fire-bricks,

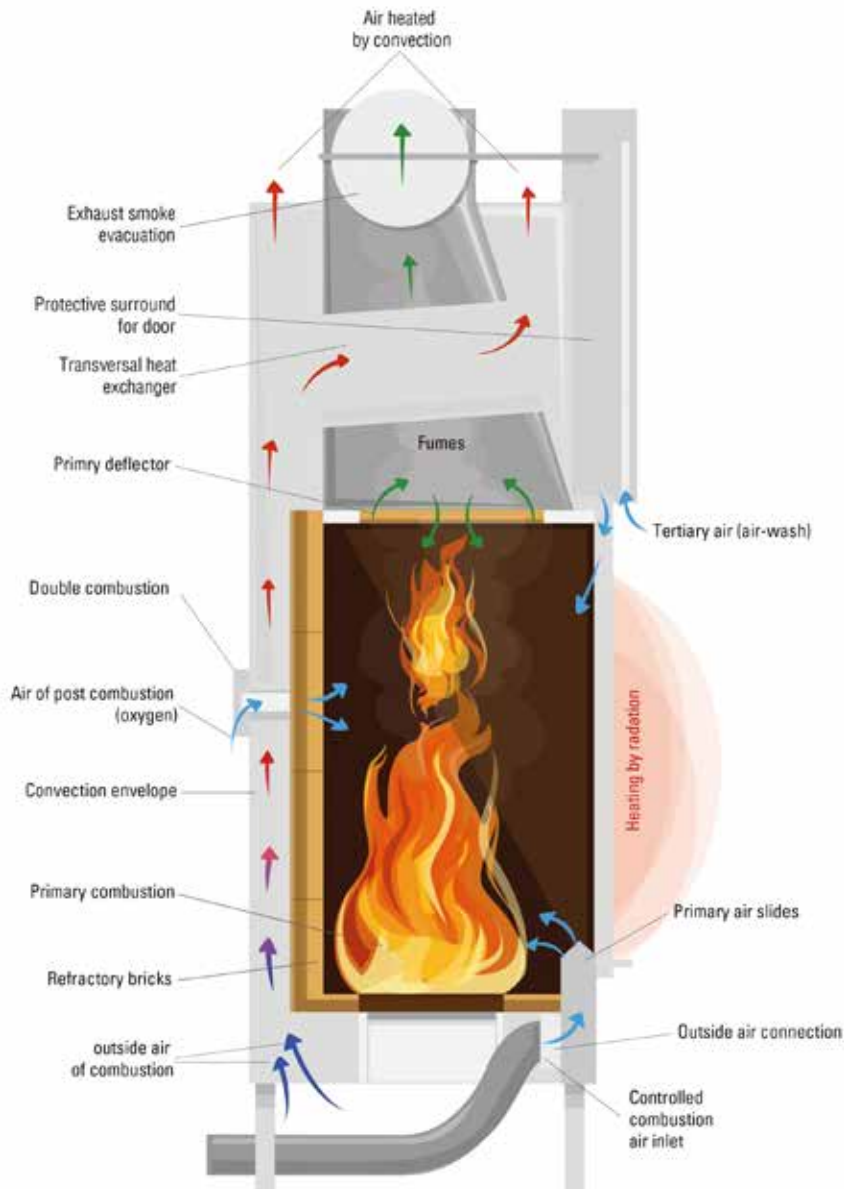

APPLIANCE DETAILS (CONTINUED)

REFRACTORY FIRE BRICKS

These inbuilt Axis fireplace are internally lined with manually assembled interlocking refractory bricks. This method avoids dilation by encouraging uniform and extended heat accumulation. While an Axis wood heater is in use, the bricks, (which are baked at 1350° Celsius during the manufacturing process) will be heated to 600° Celsius. When the fire has dissipated the heat retained inside the bricks will still radiate heat, ensuring the fireplaces long lasting heating capacity well after the fire has ceased.

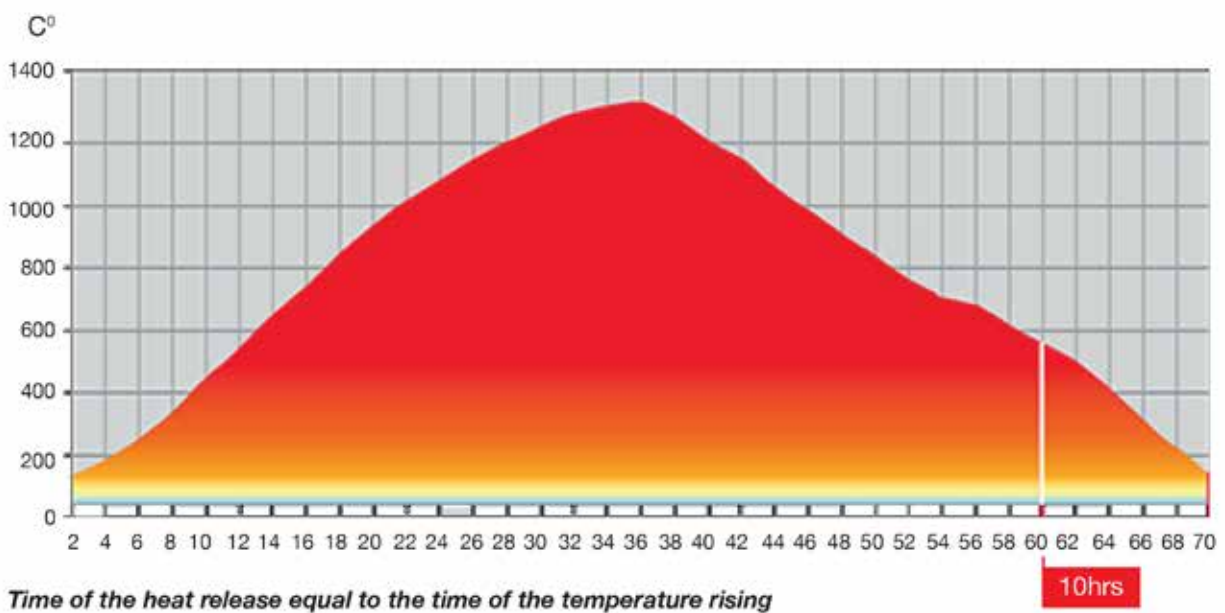

OPERATION & MAINTENANCE

OPERATING THE WOOD BURNER WITH THE DOOR OPEN EXPOSES YOU TO MULTIPLE HAZARDS (FALLING EMBERS, SMOKE EMISSIONS IN THE ROOM, ETC.). ALWAYS OPERATE THE APPLIANCE WITH THE DOOR CLOSED.

PRECAUTIONS FOR THE FIRST IGNITION - CURE WITH 10 SMALL FIRES

The first ten fires should be light, moderate and not overly loaded with wood. We recommend a small fire consisting of 3-4 logs weighing around 3kg in total.

PAINT

It is strongly recommended that no person(s) come into contact with the external faces of the appliance without the protective gloves provided, this will avoid any 'marking' on the paint surface prior to it being cured. The paint will polymerise after several fires. Do not scrub or clean the fireplace with any rough surface (such as a sponge). In the case of accidental scratches, make several fires until the paint is cured, at which time you can delicately clean the outside of the appliance with a hot sponge. Do not scratch or rub the fireplace while it is lit. It is recommended contact with the fireplace should be kept to a minimum. Do not paint the fireplace using products NOT recommended by the supplier, please contact Sculpt Fireplace Collection should you require further assistance.

Avoid scratches and markings on your appliance by not placing any objects on your appliance during operation and when not in use.

VENTILATION

A strong burning smoke odour may be smelt during the first several fires, it is therefore recommended to ventilate the premises by opening windows/doors in order for the paint to cure. This phenomenon will disappear after these initial burns cycles.

LIGHTING THE FIRE

The fire is started with the airways open. The fire-lighting starter and the combustion control must allow maximum air intake. In order to limit smoke emission, it is preferable to use the inverted or top-down fire lighting method (see illustration below). An initial load of 3kg of wood provides a good layer of embers.

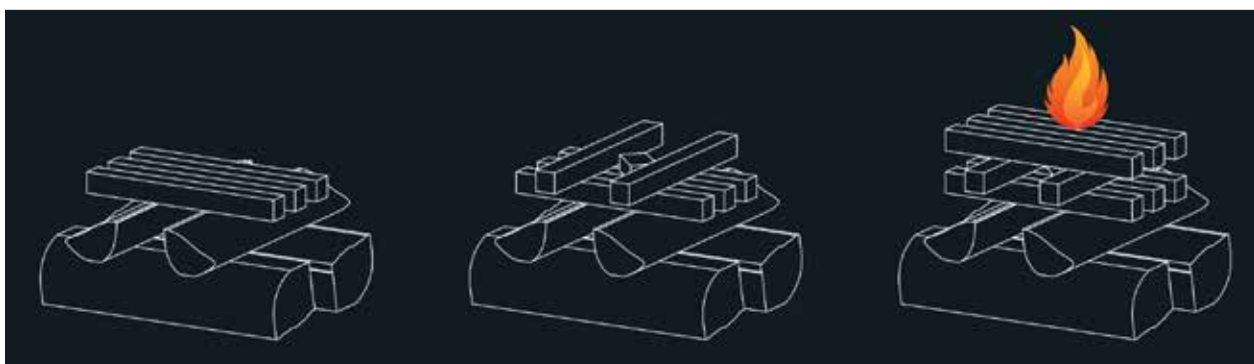

IGNITION INSTRUCTIONS

Before any ignition ensure the flue damper is open in order to accelerate combustion and evacuate the fumes. The door of the fireplace should be closed in order to avoid any risk of back-flow.

Always slowly and gradually light the fire; split wood and fire starters are recommended. It is strictly forbidden to use any volatile substances including; methylated spirits, gasoline, solvents or the likes as these will result in a risk of explosion or thermal shocks by a sudden rise of temperature.

OPERATION & MAINTENANCE (CONTINUED)

IMPORTANT

Only load wood on cast iron log grate area. Do not burn wood directly on firebrick surface.

IGNITION INSTRUCTIONS (continued)

After an extended time of non-use, it is recommended that the firebox be checked and cleaned by a professional to ensure there is no obstruction in the flue and no blocking of the manoeuvring members (damper) before ignition.

FLUE DAMPER CONTROL

The best way to control the fire is to ensure the flue damper is completely open to begin. Once the fire has been established, the flue damper should be closed.

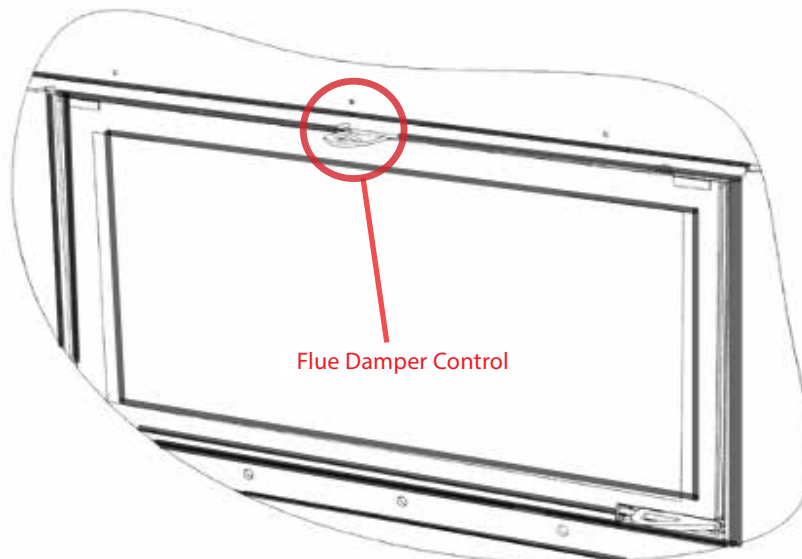

ESTABLISHING THE FIRST FIRE

Before establishing the first fire, remove all labels or equipment parts located in the ash box or in the furnace.

While building your first fire, keep the combustion rate at a moderate level to ensure that the sealant binds with the paint. All materials should be seasoned.

Please note: Before building a big fire, establish several small fires. The curing process is necessary to ensure that the paint is not damaged and that the insert is well seasoned.

Do not overload the furnace. The optimum amount of fuel should not exceed one third (1/3) of the insert volume. Before reloading, make sure that the fire has subsided. This will keep the fireplace from over-firing.

Flow of air can be regulated by the flue damper control.

Except for the short time required to build a fire, the fireplace door should be fully closed. If doors are left partly open, flue gas may be drawn out of the opening creating risks from both fire and smoke.

OPERATION & MAINTENANCE (CONTINUED)

AXIS ASH GRATE - INSTALLATION

The Axis ash grates are comprised of 2 parts. By slipping the smaller grate inside the larger grate (see figure 1), the primary airflow can be adjusted to supply combustion directly to the embers underneath.



Figure 1) Larger Ash Grate pictured with smaller grate offset to larger ash grate.

Insert the smaller ash grate into the larger ash grate. Sliding the top ash grate forward and back using the cold handle key or fire poker tool, this will adjust the airflow coming directly up into the hot embers.



Figure 2) Smaller Ash Grate pictured inside the larger Ash Grate. Also shown in fully-open position.

By sliding the Ash Grate back, the primary airflow can be adjusted. Figure 3 shows the Ash Grate in the fully-closed position.



Figure 3) Ash Grate pictured in the fully-closed position.

OPERATION & MAINTENANCE (CONTINUED)

IMPORTANT

Ventilation devices which operate with the fireplace on the same premises or on the premises which share the same ventilation shaft may not function properly.

Please ensure the airways are never blocked.

During installation please allow for access to have the fireplace and the connecting shaft cleaned.

If required, install cut-off and stifling devices.

RECOMMENDED FUEL

This fireplace is designed for only wood fuel. Any fuel other than wood is strictly forbidden.

As a general rule it is recommended; use dry, well-seasoned HARD WOOD with a 15% moisture content or less in order for the unit to burn effectively and avoid any tarring. The heating output of wood depends on the moisture percentage.

AVERAGE WOOD DRYING TIME BASED ON MOISTURE CONTENT

	C	L		C	L
DIRECTLY CUT	75%	78%	1 YEAR	33%	35%
3 MONTHS	48%	62%	1 1/2 YEAR	18%	27%
6 MONTHS	37%	46%	2 YEARS	16%	24%
9 MONTHS	36%	38%	2 1/2 YEARS	15%	24%

C: Chunks L: Logs

If the wood is piled up loosely, it will burn faster because the necessary oxygen for the combustion will easily reach every piece of wood. This piling is recommended if you want to heat over a short period of time. When the wood is piled more compact, it will burn slower because the oxygen won't reach all the logs at the same time. This piling is recommended if you want to heat over a longer period of time.

IT IS FORBIDDEN TO PERMANENTLY OPERATE THIS FIREBOX WITH THE DOOR OPEN.

SWING DOOR: Should only be used during maintenance.

LIFT DOOR ONLY: Slowly raise the door; do not open quickly whilst the fire is alight. Completely open the damper prior to opening the door. In the case of the unit being used with the door open, please be aware that the heating capacity will be significantly reduced. This configuration is only justified for visual comfort of the fire and is NOT recommended for permanent use.

DOUBLE SIDED FIREBOX: Never leave both doors open at the same time.

ATMOSPHERIC CONDITIONS

Misty or foggy weather may possibly favour back-flow of the smoke, which may be a health hazard. In this case only use the fireplace as is necessary.

For safety reasons, assemblies of appliances and accessories not provided or recommended by Axis or Sculpt Fireplaces are NOT PERMITTED. Unsuitable equipment may cause dysfunctions and disorder upon use.

EXTINGUISHING THE FIRE

Stop fuelling the fire and let it burn out. The fire should burn out without any constraints.

CAUTION: Do not hang or install objects within 2m of the appliance. This includes paintings, photos, televisions, and any other combustible materials.

OPERATION & MAINTENANCE (CONTINUED)

IMPORTANT WARNING

Storing any flammable materials (paper, linen, furniture, solvents, flammable liquids, spray containers, gas bottle, etc.) close to the fireplace is strictly forbidden.

All these products should never be stored even for a short while in wood storages or recesses laid out under or near the appliance.

CAUTION: The window, the front panel of the appliance, as well as all external faces including the facade, will attain high temperatures (above 100°). Uninitiated persons, young children and infants should be monitored at all times while in the vicinity of the appliance.

SLOW BURNING

Please be aware that this method may cause unburnt matter to accumulate in the flue system. This may in the long term cause a chimney fire. Our recommendation is to therefore avoid closing the damper for an extended length of time. Use only dry hard wood with a maximum moisture content of 15% to assist in reducing creosote build up, and regularly light a high intensity fire to burn off the build up.

A draught is created from the difference in temperature between the interior and the exterior flue. The higher the temperature inside the flue, the more intense the draught is. Before closing the air inlets and reducing the combustion level in the stove for a slow burn, the temperature inside the flue must be high enough to adequately draw all the flue gas.

CAUTION: Continuous and intensive slow burn operation may cause early deterioration of the appliance and its components, as well as a chimney fire if the flue has not been regularly cleaned.

TRANSITION PERIOD, INSUFFICIENT CHIMNEY DRAUGHT AND POOR WEATHER CONDITIONS

Pay attention to the operations of the insert during transition periods and/or when chimney draught is insufficient or when weather conditions are unfavourable, especially during severe cold weather. Such conditions may cause flue gas to flow into the room. To prevent such a situation, you should reduce the intensity of fire by curbing the influx of air into the combustion chamber until smoke disappears. Afterwards you may increase air flow monitoring for any appearance of smoke in the room.

MAINTENANCE

The vitro-ceramic glass can withstand temperatures of up to 750°C. If the glass breaks following a handling error, it is not recommended to replace it using a material other than that supplied by the manufacturer. The original glass quality must be used to maintain any warranty of the wood stove.

CLEANING THE GLASS

The window of the fireplace requires regular cleaning with specific products intended for this use. The use of moist hard wood with a moisture content above 15% causes excessive creosote build up on the glass. Once again we recommend only burning very dry hard wood.

We recommend waiting for the glass to cool before cleaning it. The use of products that are too aggressive (eg. abrasive cleaners) may lead to the deterioration of some of the wood heater parts. An effective and ecological method of cleaning the glass is to use a piece of damp newspaper dipped in ash and then rinsing with clean water. You can also use a commercially available glass cleaning product.

MAINTENANCE (CONTINUED)

FLUE & FIREBOX

Flues should be professionally cleaned and checked twice a year, including at least once during the peak period of use, and more if required. A professional should also check seals, door ropes, glass positioning, door alignment, flue damper controls, baffle plates and all consumable parts of the firebox and flue to ensure the unit is in safe working order.

DO NOT REMOVE THE BAFFLE EXCEPT WHEN PERFORMING A CHIMNEY SWEEP

CAUTION: Cracked and/or broken components (eg. glass panels or baffles) may render the installation/operation unsafe. Do not use the appliance if this is the case and contact your dealer.

ASH PAN

The ash pan should be emptied regularly in order to avoid any overflow and clogging of the fire grate. Use the cold handle supplied and pull the ash pan from the appliance. You will find some ashes catching in the cavities between the ribs of the fireplate. This bed of ashes caught between the fireplate is essential as it will create a more effective start up operation of the fire.

FORBIDDEN FUELS

This appliance is not designed for burning the following fuels:

- Solid mineral fuels (all coals or similar)
- Liquid mineral fuels (Gasoline, fuel oil, solvents, drainage oils or similar)
- Methylated spirit
- Creosote-treated woods and too moist or green woods
- Paper or cardboard
- Wood workshop residues (Shavings, saw dusts or similar)
- Other forbidden fuels that may harm the appliance or the environment

CHIMNEY SWEEPING

Prior to using and installing into an existing chimney, it's necessary to perform a chimney sweep and ensure it's clear of any build up (creosote, bird's nest, etc). Chimney sweeps should be performed twice a year, including at least once during the period of use.

CHIMNEY FIRES

Chimney fires can be caused due to incorrect use of the appliance and lack of periodic cleaning.

Visible signs of a chimney fire include:

- Abundant fumes
- Strong smell of soot
- Roaring in the flue
- Significant increase in the temperature of the flue
- Cinders flying out of the top of the flue

MAINTENANCE (CONTINUED)

CHIMNEY FIRES (CONTINUED)

Suggested course of action in case of chimney fires:

1. Put out the fire by carefully removing the glowing logs and fully close the fireplace door.
2. Use a chimney sieve screen (metal mesh 2 x 10mm, preferably brass, on a 60x60cm frame). Place the screen on the chimney top and inspect the lower parts for cracks through which fire flames may escape. A hot screen reduces the draught in the chimney and, consequently, slows down the soot burning process.
3. When required, call the Fire Department.

In the event of any emergency, put out the fire immediately by cutting off airflow into the insert and, where necessary, cover glowing wood with sand. Try to remove fuel from the hearth.

Do NOT use water to put out the fire as it may cause permanent damage.

TROUBLESHOOTING AND COURSE OF ACTION TO PUT OUT THE FIREPLACE IN THE EVENT OF AN EMERGENCY.

NOTE: These course of actions are only recommendations. For more detailed information contact your dealer or licensed technician

Symptoms	Possible cause	Proposed course of action
1. Smoke comes from the fireplace	<ol style="list-style-type: none"> 1. Air supply ventilation is choked 2. Size of chimney shaft or its length is not sufficient 3. Fault location of chimney relevant to roof ridge 4. No chimney cap installed 5. Improper connection of insert with smoke shaft 6. Chimney not clear 	<ol style="list-style-type: none"> 1. Provide a clear ventilation shaft 2. Extend chimney 3. Extend chimney 4. Mount chimney cap 5. Apply reducer between fireplace insert and smoke shaft 6. Call authorised specialist
2. Ash comes from the fireplace	Too much ash in ash box	Remove ash from ash box, clear grate
3. Glass becomes dirty	Most likely improper firewood used (too much resin, too wet or wood from coniferous trees) or inadequate draught in chimney	Use special cleaning agent or clean ash from fireplace. If inadequate draught, see other troubleshooting suggestions.
4. Starting a fire is a problem or fire is weak	<ol style="list-style-type: none"> 1. Logs too thick 2. Wood too wet 3. Ash box full 4. Chimney cold 5. Air supply installation malfunctions 6. Chimney not clear 	<ol style="list-style-type: none"> 1. Use recommended fuel 2. Use seasoned firewood 3. Remove ash from ash box, clear grate 4. Heat up chimney by burning more paper 5. Provide or clear ventilation shaft 6. Call authorised specialist
5. Fire is too strong	<ol style="list-style-type: none"> 1. Fireplace door open 2. Too strong draught in chimney 	<ol style="list-style-type: none"> 1. Close door 2. Install draught regulator
6. Movable part is damaged in use (grate, baffle board, rear panel, side panels, glass plate, seals)	Parts subjected to normal wear and tear need to be replaced (not covered by warranty - see warranty terms and conditions)	Buy new spares from the dealer (dealers information can be found on the website: https://sculptfireplaces.com.au/stockists/)

TEST REPORTS

H1200/DS | H1400 | H1600/DS | H1600XXL/DS | H1200 3V | H1200VLG/D | EPI950

DUCTED HEAT TRANSFER APPLIANCE TEST

TESTING LABORATORY	HRL Technology
MANUFACTURER	AXIS
MODEL	H1200, H1200DS, H1400, H1600, H1600DS, H1600XXL, H1600XXLDS, H1200 3V, H1200VLD, H1200VLG, EPI950
ISSUE DATE	18.11.2015 Steve Marland
INVESTIGATING OFFICE RESULTS	We have examined the H1200, H1200DS, H1400, H1600, H1600DS, H1600XXL, H1600XXLDS, H1200 3V, H1200VLD, H1200VLG and EPI950 ducted appliances. The firebox volumes are larger than the tested H1200 ducted appliance.
CONCLUSION	Since the H1200 complies with the requirements of AS/NZS4013: 2014 clause 1.2.3 (b), (maximum heat output greater than 25kW (30kW) as tested and is intended for space heating by means of transferring heat to the living area by ducted hot air), than the H1200DS, H1400, H1600, H1600DS, H1600XXL, H1600XXLDS, H1200 3V, H1200VLD, H1200VLG and EPI950 ducted appliances are expected to give a higher output.

WARRANTY

Axis fireboxes are guaranteed for 5 years on the general structure of the firebox and the door lifting mechanism. A 10 year warranty is guaranteed on refractory firebricks. 2 year warranty is guaranteed on wearing parts including ash pans, ash grates and fire grate retainers.

Excluded from the Axis warranty guarantee, are all consumable parts, such as; door seals, glass, ropes, gaskets, baffle plates, appliance joints, thermal screens, moveable parts, and any degradation resulting from poor maintenance or incorrect use.

The warranty becomes effective at the date of purchase.

WARRANTY DOES NOT COVER

1. Door seals, ropes, gaskets and glass.
2. Any form of rust and/or corrosion to the painted finish of the heater.
3. Salted air of a coastal region or a highly humid environment may contribute to some oxidation of the cast iron, in this case the warranty is therefore not valid for damages originating from these causes.
4. All defects or faults resulting from poor maintenance, inappropriate use or a non-compliant installation which does not abide by Australian & New Zealand Standards AS/NZS 2918:2018, AS/ NZS 4012/4013(2014) and all applicable local installation regulations, or instructions are listed in this manual are not warranted.
5. Any device or accessory not provided by Seguin Duteriez or Sculpt Fireplace Collection are strictly forbidden and will result in a void of all warranties by the manufacturer and distributor.
6. No modifications can be made to the firebox or to original components supplied with the appliance.
7. The manufacturer and distributor are by no means responsible for any indirect damage originating from a handling accident.
8. Cost of removal of a defective heater or re-installation of a replacement heater is not covered.
9. All warranties are void if the unit is outside and exposed to the elements
10. Over firing of fireboxes will void all warranties

PERFORMANCE

The performance of our fireplaces are given as an indication and comparison after testing under optimum conditions. These values reported under standard conditions may be subject to variations if the installation and conditions of use are not equivalent to tested conditions. In any case, the closed fireplace remains a supplementary form of heat and should not replace a main heating system.

WARRANTY CLAIMS

In the case of a faulty part, the user should immediately inform the retailer.

For all warranty claims, Sculpt Fireplace Collection will require photos, proof of purchase, servicing history where applicable and the date of installation along with the compliance certificate from your licensed installer.

The guarantee is strictly limited to the exchange or repair by Sculpt Fireplace Collection of parts agreed to be defective, without exception. Costs of dismantling, installation, assembly and transport will under no circumstance be covered by this warranty by the manufacturer, retailer or distributor, and should be handled between the user and installer.

PRODUCT REGISTRATION CARD

DATE OF PURCHASE
PLACE OF PURCHASE
DATE OF INSTALLATION
COMPLIANCE CERTIFICATE NO.
MODEL NO.
NAME AND ADDRESS OF PURCHASER
PHONE NO.
EMAIL ADDRESS
Please include a copy of your receipt and compliance certificate

EMAIL PRODUCT REGISTRATION INFORMATION TO
info@sculptfireplaces.com.au



Whilst every effort is taken to avoid errors, SCULPT FIREPLACE COLLECTION cannot accept responsibility for the accuracy of any statement, extract or information contained within this manual nor can any of its contributors who have submitted material for inclusion. SCULPT FIREPLACE COLLECTION may change or update this manual and anything described within it without notice. We will endeavour to ensure that information, materials and data on this site are complete, accurate and up-to-date. Information on this manual is for guidance only and cannot cover all circumstances. E&OE

Sculpt Fireplace Collection is an Australian owned company who exclusively supply some of world's most sought after high-end luxury fireplaces.

Intent on providing Australians with a dynamic collection of designer fires, Sculpt Fireplace Collection has strategically gathered not only award winning fireplace designs, but also fireplaces that have been manufactured with high quality materials and the best raw steel that is built to last.

Our wood fire manufacturers integrate innovation, technology, environmental impact, operational expertise and quality, while holding design at the forefront. We aim to fill homes with the maximum of comfort while capturing the true art and meaning of a sculptural fireplace in any living space.



JC BORDELET
créateur d'harmonie

SEGUIN
DUTÉRIEZ

Sculpt is proud to be the sole importer of Seguin, Axis and JC Bordelet fireplaces, with exclusive distribution rights throughout Australia and New Zealand.

Whilst every effort is taken to avoid errors, SCULPT FIREPLACE COLLECTION (Sculpt Fireplaces Pty Ltd) cannot accept responsibility for the accuracy of any statement, extract or information contained within this manual nor can any of its contributors who have submitted material for inclusion. SCULPT FIREPLACE COLLECTION may change or update this manual and anything described within it without notice. We will endeavour to ensure that information, materials and data on this site are complete, accurate and up-to-date. Information on this manual is for guidance only and cannot cover all circumstances. E&OE



SCULPTTM
FIREPLACE
COLLECTION

1300 851 304
info@sculptfireplaces.com.au
sculptfireplaces.com.au

Edition: 26/10/2022